

ANT-20SE

Advanced Network Tester

Optical Interfaces up to 155 Mbit/s
BN 3060/91.01 and BN 3060/91.02

Optical Interfaces up to 622 Mbit/s
BN 3060/91.11 and BN 3060/91.12

Optical Interfaces STM-16/OC-48
BN 3060/91.50 through BN 3060/91.53

Optical Interfaces STM-64/OC-192
BN 3060/91.40 through BN 3060/91.42

Drop&Insert
BN 3060/90.10
in combination with Optical Interfaces

Software Version 7.20

Operating Manual

Please direct all enquiries to your local Wavetek Wandel Goltermann sales company. The addresses are given at the end of this handbook.

Copyrights

This product or parts of it are based upon Recommendations and/or Standards of the Standardization Sector of the International Telecommunication Union - ITU-T and/or of the European Telecommunications Standards Institute - ETSI. These Recommendations and Standards are subject to copyrights of these organizations. Without written permission of the ITU-T and/or ETSI it is not permitted to copy ITU-T Recommendations or ETSI standards or parts thereof and/or make them available to third parties.

Wavetek Wandel Goltermann
Eningen GmbH & Co.
Mühleweg 5, 72800 Eningen u. A.
© 2000

Author: MDD/TD
Translator: John Nutley

Order no.: BN 3060/98.26
Edition: 02/00.07 (V 7.20)

Previous edition:
01/00.04 (V 7.1)

Subject to change without notice
Our normal guarantee and delivery
terms apply

Printed in Germany



Contents

Introduction

1	Optical interfaces for signals up to STM-64/OC-192	I-1
2	SOH/TOH loading and analysis	I-1
3	Drop&Insert function	I-1
4	ADM Tester	I-1
5	Optical power splitter	I-2
6	STM-16/OC-48 Module connector panel	I-3
7	STM-64/OC-192 Module connector panel	I-4

Maintenance

1	Important safety instructions	M-1
2	Cleaning the optical interfaces	M-2
3	Installing the optical interface	M-3
3.1	Safety precautions for preventing electrical accidents	M-3
3.2	Measures for preventing electrostatic damage	M-3
3.3	Important operating information	M-4
3.4	Installation instructions STM-16/OC-48	M-5
3.4.1	ANT-20SE operation with the STM-16/OC-48 modules	M-5
3.5	Installation instructions STM-64/OC-192	M-7
3.6	Affixing the laser safety warning labels	M-8

Specifications STM-0/1/4/OC-1/3/12

1	Generator section	S-1
1.1	Digital signal output	S-1
1.1.1	Signal output [18], optical	S-1
1.2	Clock generator and bit rates	S-2
1.2.1	Clock generation	S-2
1.2.2	Bit rates	S-2

1.3	SDH and SONET TX signals	S-2
1.3.1	STM-4 TX signal	S-2
1.3.2	STM-1 TX signal	S-2
1.3.3	STM-0 TX signal	S-3
1.3.4	OC-12 TX signal	S-3
1.3.5	OC-3 TX signal	S-3
1.3.6	OC-1 TX signal	S-3
1.3.7	Scrambling	S-3
1.3.8	Overhead generator	S-4
1.3.8.1	Section overhead (SOH), Transport Overhead (TOH)	S-4
1.3.9	Error insertion (anomalies)	S-5
1.3.10	Alarm generator (defects)	S-6
1.4	Output signals for the ADM Tester	S-7
1.4.1	Optical output signal	S-7
1.4.2	PDH output signal	S-7
2	Receiver section.	S-8
2.1	Digital signal inputs	S-8
2.1.1	Signal input [17], optical	S-8
2.1.2	Signal input [16], electrical	S-9
2.1.3	Clock recovery	S-9
2.2	SDH and SONET RX signals	S-10
2.2.1	STM-4 RX signal	S-10
2.2.2	STM-1 RX signal	S-10
2.2.3	STM-0 RX signal	S-10
2.2.4	OC-12 RX signal	S-10
2.2.5	OC-3 RX signal	S-10
2.2.6	OC-1 RX signal	S-10
2.2.7	Descrambling	S-11
2.3	Measurement modes	S-11
2.3.1	Alarm detection (defects)	S-11
2.3.2	Error measurements (anomalies)	S-11
2.3.3	Section overhead (SOH) and transport overhead (TOH) evaluation	S-12
3	Optical power splitter BN 3035/90.49	S-13
3.1	Wavelength ranges	S-13
3.2	Attenuation	S-13

4	Drop&Insert / Through Mode / Block&Replace	S-14
4.1	Functions	S-14
4.1.1	Clock generator	S-17
4.1.2	Overhead generator	S-17
4.1.3	Anomaly insertion	S-17
4.1.4	Defect generation	S-18
4.1.5	Measurements	S-18
4.2	Signal outputs	S-19
4.2.1	AUXILIARY signal output [11], electrical	S-19
4.2.2	LINE/AUXILIARY signal output [13], electrical	S-19
4.3	Signal inputs	S-20
4.3.1	AUXILIARY signal input [10], electrical	S-20
4.3.2	LINE/AUXILIARY signal input [12], electrical	S-20

Specifications STM-16/OC-48

1	Generator section	S-23
1.1	Digital signal output	S-23
1.1.1	Signal output [47], optical	S-23
1.1.2	Signal output [46], electrical	S-24
1.2	Clock generator and bit rates	S-24
1.2.1	Clock generation internal	S-24
1.2.2	Clock generation external [45]	S-24
1.2.3	Bit rate	S-24
1.2.4	Clock output [41]	S-25
1.3	SDH and SONET TX signals	S-25
1.3.1	STM-16 TX signal	S-25
1.3.2	OC-48 TX signal	S-25
1.3.3	Scrambling	S-25
1.3.4	Overhead generator	S-26
1.3.4.1	Section overhead (SOH), Transport overhead (TOH)	S-26
1.3.5	Error insertion (anomalies)	S-28
1.3.6	Alarm generator (defects)	S-28
1.4	Output signals for the ADM Tester	S-29
1.4.1	Optical output signal	S-29
1.4.2	PDH output signal	S-29

2	Receiver section	S-30
2.1	Digital signal inputs	S-30
2.1.1	Signal input [44], optical	S-30
2.1.2	Signal input [43], electrical	S-31
2.1.3	Clock output [42].	S-31
2.2	SDH and SONET RX signals	S-32
2.2.1	STM-16 RX signal.	S-32
2.2.2	OC-48 RX signal	S-32
2.2.3	Descrambling	S-32
2.3	Measurement modes	S-33
2.3.1	Alarm detection (defects)	S-33
2.3.2	Error measurements (anomalies)	S-33
2.3.3	Section overhead (SOH) #1, Transport overhead (TOH) #1 evaluation	S-34
3	Optical power splitter BN 3035/90.49	S-35
3.1	Wavelength ranges	S-35
3.2	Attenuation	S-35
4	Drop&Insert / Through Mode	S-36
4.1	Functions	S-36
4.1.1	Clock generator.	S-38
4.1.2	Overhead generator	S-38
4.1.3	Anomaly insertion	S-38
4.1.4	Defect generation	S-38
4.1.5	Measurements	S-38
4.2	Signal outputs	S-39
4.2.1	Signal output [15], electrical	S-39
4.2.2	LINE/AUXILIARY signal output [13], electrical	S-39
4.3	Signal inputs	S-40
4.3.1	AUXILIARY signal input [10], electrical.	S-40
4.3.2	LINE/AUXILIARY signal input [12], electrical	S-41
5	Additions for SOH	S-42
5.1	Generator section	S-42
5.1.1	Overhead generator	S-42
5.1.1.1	Section overhead (SOH), Transport overhead (TOH)	S-42



5.1.2	Error insertion (anomalies)	S-43
5.2	Receiver section	S-45
5.2.1	Section overhead (SOH), Transport overhead (TOH) evaluation.	S-45

Specifications STM-64/OC-192

1	Generator section.	S-47
1.1	Digital signal output	S-47
1.1.1	Signal output [103], optical	S-47
1.2	Clock generator and bit rates	S-48
1.2.1	Internal clock generation	S-48
1.2.2	External clock generation [101].	S-48
1.2.3	Bit rate	S-48
1.2.4	Clock output [102].	S-48
1.2.5	Frame trigger output [100].	S-48
1.3	SDH and SONET TX signals.	S-49
1.3.1	STM-64 TX signal	S-49
1.3.2	OC-192 TX signal	S-49
1.3.3	Scrambling	S-49
1.3.4	Overhead generator	S-50
1.3.4.1	ITU-T Standard	S-52
1.3.4.2	ANSI Standard	S-55
1.3.5	Error insertion (anomalies)	S-57
1.3.6	Alarm generator (defects)	S-57
2	Receiver section	S-58
2.1	Digital signal input	S-58
2.1.1	Signal input [113], optical	S-58
2.2	Outputs for RX clock and frame trigger.	S-59
2.2.1	Clock output [112].	S-59
2.2.2	Frame trigger output [110].	S-59
2.3	SDH and SONET RX signals	S-59
2.3.1	STM-64 RX signal	S-59
2.3.2	OC-192 RX signal	S-59
2.3.3	Descrambling	S-59



- 2.4 Measurement modes S-60
 - 2.4.1 Alarm detection (defects) S-60
 - 2.4.2 Error measurements (anomalies) S-60
 - 2.4.3 Section overhead (SOH) #1 to #64,
Transport overhead (TOH) #1 to #192 evaluation S-61
- 3 Optical power splitter BN 3035/90.49 S-62**
 - 3.1 Wavelength ranges S-62
 - 3.2 Attenuation S-62
- 4 Note for ANT-20SE users. S-63**



Introduction

Glass optical fibers are generally used as the transmission medium for SDH, SONET and ATM networks. Increasing integration has meant that the optical line equipment forms part of the network elements. The test equipment used for testing these elements must therefore be fitted with optical interfaces.

1 Optical interfaces for signals up to STM-64/OC-192

The ANT-20SE provides optical interfaces for signals from 52 Mbit/s (STM-0/OC-1) to 9953 Mbit/s (STM-64/OC-192) in a single, compact instrument.

2 SOH/TOH loading and analysis

A wide range of functions for simulation and analysis of informations are provided in the overhead, e.g. editor and monitor, together with bit error measurements and a V.11 interface for DCCs and a path trace feature for J0 through J2. This permits precise assessment of the SDH/SONET-specific characteristics of the network elements.

3 Drop&Insert function

(not for STM-64/OC-192)

When equipped with the Drop & Insert function, the ANT-20SE provides access to all layers below the transmission rate. This function also includes loop-through operation. The ANT-20SE can thus be inserted into the optical path instead of using the optical power splitter to extract the signal.

4 ADM Tester

(not for STM-64/OC-192)

In "ADM Tester" mode, the ANT-20SE generates an optical output signal in addition to the transmitted PDH signal. This optical signal can be used to test devices that disable their optical outputs if no optical input signal is present (laser safety disable function).

5 Optical power splitter

The ANT-20SE has a built-in optical power splitter. Looping the optical path through the splitter provides a transparent optical monitoring point. The ANT-20SE can thus perform in-service analysis of the signals on the optical path.

6 STM-16/OC-48 Module connector panel

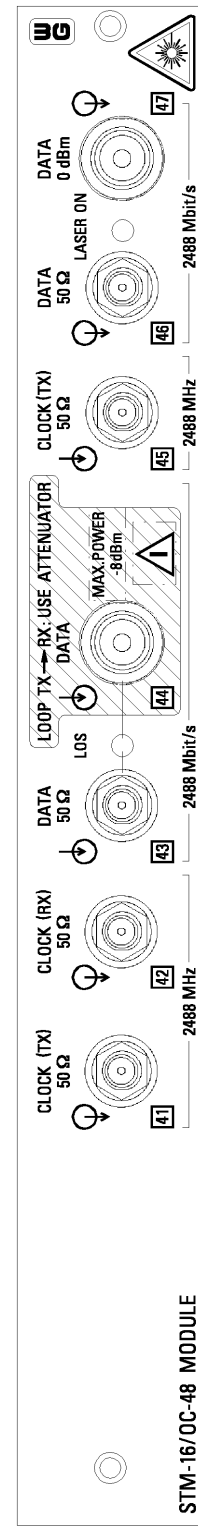
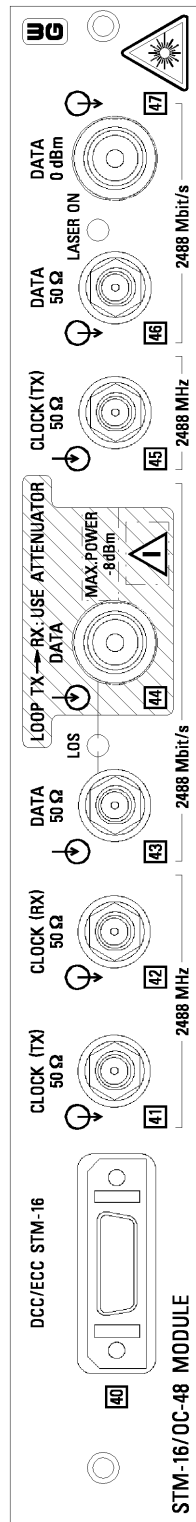

Fig. I-1 STM-16/OC-48 Module connector panel

7 STM-64/OC-192 Module connector panel

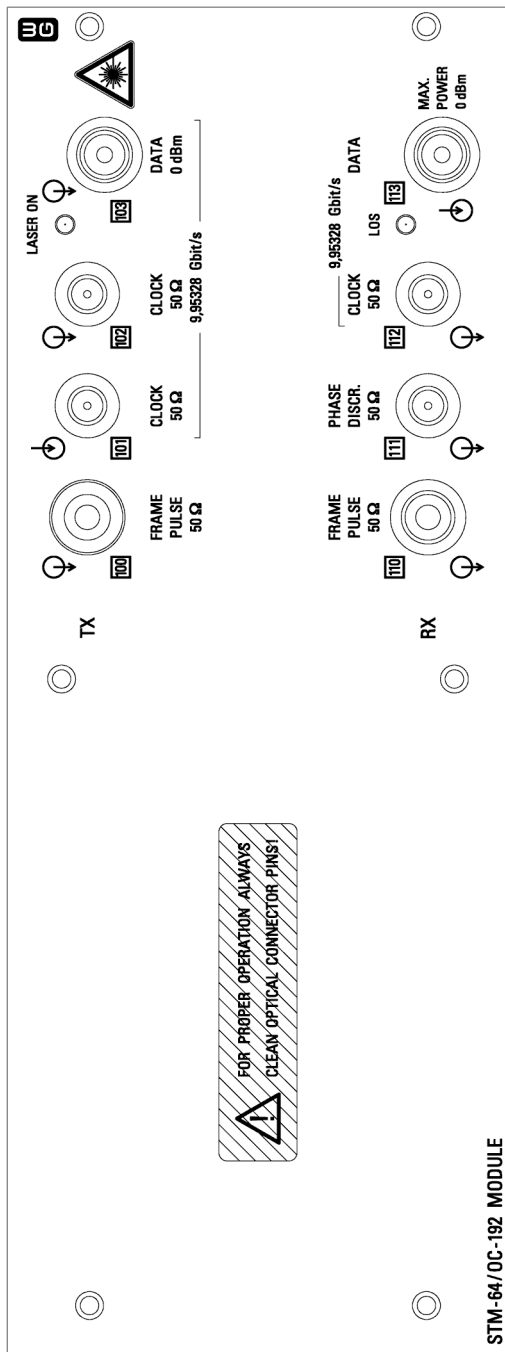

Fig. I-2 STM-64/OC-64 Module connector panel

Maintenance

1 Important safety instructions

The following options for the ANT-20SE are fitted with laser output devices:

- BN 3035/90.40 through BN 3035/90.59
- BN 3035/91.40
- BN 3035/91.41
- BN 3035/91.53 through BN 3035/91.59

Optical radiation with wavelengths in the range 1300 to 1600 nm is present at sockets [18], [47] and [103].

Maintenance and repair work on the laser sources should only be carried out by qualified service operatives familiar with the risks involved.

The laser source is active if the yellow LED next to the connector is on.

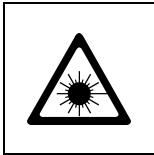

Caution

Invisible laser radiation

Laser light can cause irreparable damage to the eyes, particularly to the retina.

- ⇒ Never look directly into the generator outputs [18], [47] and [103] or the connector end surfaces of the connected cables (free ends) if the laser sources are activated.
- ⇒ Never use a microscope to check the generator outputs if the laser sources are activated.
- ⇒ Do not activate the laser sources until all measurement connections have been made.

The output power at socket [18] of the STM-4/OC-12 module is within the limits for a CLASS 1 LASER PRODUCT.

The output power at socket [47] or [103] of the STM-16/OC-48 module or STM-64/OC-192 is also within the limits for a CLASS 1 LASER PRODUCT (IEC 825-1: 1993) during normal operation. Under fault conditions, the output power level may exceed these limits and the output is then a CLASS 3A LASER PRODUCT (IEC 825-1: 1993).

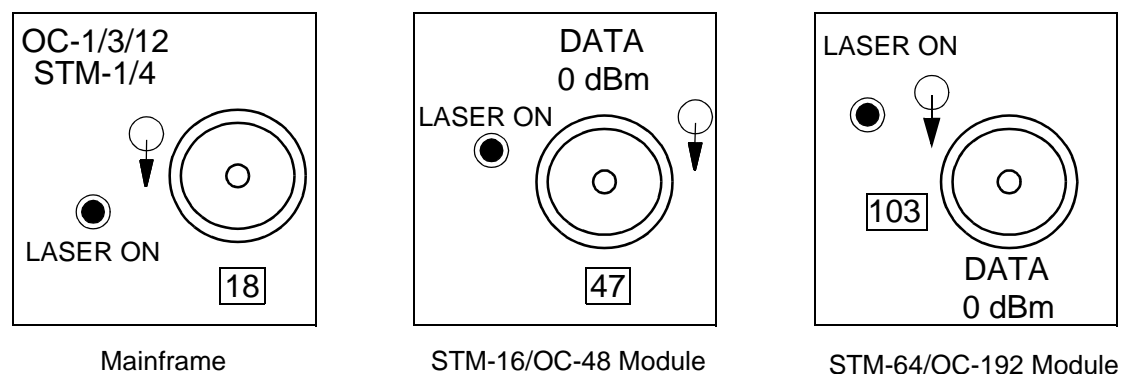

Fig. M-1 ANT-20SE optical connections

2 Cleaning the optical interfaces

Follow the instructions below when cleaning the optical interfaces [17], [18], [44], [47], [103] and [113] (see Fig. M-2):

1. Always observe the laser safety precautions!

2. Remove the test adapter and protective cap (a).
The internal plug pin is now easily accessed.
3. If the plug pin is very dirty, dab it lightly with a piece of adhesive tape (e.g. Scotch "Magic tape"), then remove the tape (b).
For on-site cleaning, we recommend the use of "Cleaning tape for optical connectors", BN 2229/90.07.
4. If the plug pin is not very dirty, dampen a lint-free paper tissue with isopropanol and wipe off the end surface of the plug pin (c).
5. Dry off the end surface of the plug pin using a dry paper tissue (d).
6. Blow out the test adapter and protective cap using clean, compressed air.
7. Replace the test adapter and protective cap on the connector.

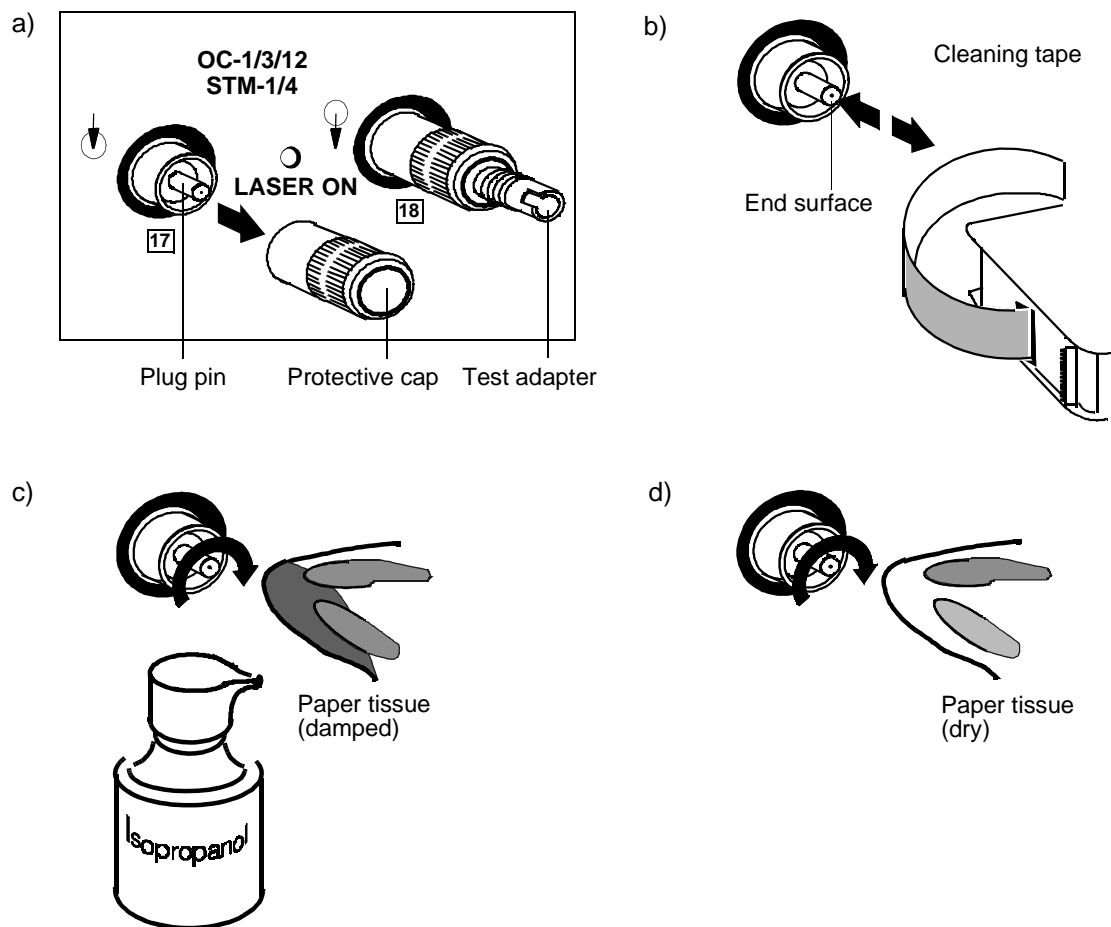

Fig. M-2 Cleaning the test connectors

A suitable microscope is required for inspecting the plug end surfaces. This should have a magnification of about 200 x.

3 Installing the optical interface

3.1 Safety precautions for preventing electrical accidents

Opening covers or removing parts with a tool can expose live parts. Terminal points may also be live.

Disconnect the instrument from all voltage sources before opening it. If calibration, maintenance or repair of the open instrument must be carried out with power connected, then this should be performed by a trained technician who is familiar with the risks involved.

Capacitors in the instrument may retain charge even when the instrument has been disconnected from all voltage sources. Heed the circuit diagrams!

3.2 Measures for preventing electrostatic damage

Electrostatic charges and fields can damage or even destroy semiconductors.

It is thus necessary to protect all semiconductor components used in this instrument against electrostatic charges and fields.

When the instrument is closed, this is no problem. When the instrument is open, electrostatically susceptible boards and subassemblies are designated with the DIN 40 021 warning symbol. Special measures must be taken to protect these boards and subassemblies.



Fig. M-3 Warning symbol to DIN 40 021

Special measures

Grounded person	Only "grounded persons" working at an electrostatically protected workstation may reach into the instrument.
Wristband	The technician must be grounded via the wristband of the electrostatically protected workstation.
Grounding cable	The grounding cable is connected to ground (earth) potential. The following can be considered to be at ground potential: <ul style="list-style-type: none"> • the instrument ground jack • the protective earth connection • another device at ground potential

3.3 Important operating information



Caution

Destruction of input [44]

The maximum input level of -8 dBm must not be exceeded. Otherwise, the optical input can be destroyed.

- ⇒ Insert an optical attenuator in any case:
- for RX - TX loop operation
 - for higher input levels



Caution

Destruction of input [103]

The maximum input level of 0 dBm must not be exceeded. Otherwise, the optical input can be destroyed.

- ⇒ Insert an optical attenuator in any case for higher input levels.



Caution

Damage to the optical inputs and outputs

The optical input and output can be damaged if the connecting cables are inserted at an angle when connecting up.

- ⇒ Make sure that the angle of the connecting cable to the connector does not exceed 10°.
- ⇒ Make sure that the tongue on the connector of the cable is fitted exactly in the slot of the adapter before you do up the screw fastening of the connecting cable.

3.4 Installation instructions STM-16/OC-48

Preparation

1. **Disconnect the ANT-20SE from the AC line and all test circuits.**
2. **Heed the measures for preventing electrostatic damage.**
Do not remove the STM-16/OC-48 optical interface from its package until you are ready to install it.
3. Place the ANT-20SE with its screen upwards. The side with the connectors should be facing you.

Installation

To install the STM16/OC-48 optical interface, proceed as follows:

1. Remove the "Extension slot" cover plate, two screws.
2. Remove the dummy plate, four screws.
3. Open the bag containing the optical interface STM-16/OC-48.
The bag protects the interface module from electrostatic damage.
4. Remove the interface module.
5. Remove the premounted cover plate, four screws.
6. Insert the interface module into the "Extension slot".
7. Screw the interface module to the chassis, four screws.
8. Install the cover plate (four screws).
9. Affix the laser safety warning label for a Class 3A laser product (see Fig. M-7).

3.4.1 ANT-20SE operation with the STM-16/OC-48 modules

- Wavelength 1550 nm: BN 3035/90.53 or BN 3035/91.53
- Wavelength 1310 nm: BN 3035/90.54 or BN 3035/91.54
- Wavelength 1310 and 1550 nm: BN 3035/90.59 or BN 3035/91.59

The STM-16/OC-48 modules with their specific wavelengths can be operated only in a certain ANT-20SE slot position (see Fig. M-4). The slot position depends on whether the "2488 Mbit/s Jitter Analyzer/Generator" module (BN 3035/90.68) is simultaneously fitted or not.

Removing the module

1. **Disconnect the ANT-20SE from the AC line and all test circuits.**
2. **Heed the measures for preventing electrostatic damage.**
3. Remove the cover plate (two screws).
The four screws fixing the module are accessible.
4. Remove the four screws.
5. Remove the module.

Inserting the module

1. Insert the module in the scheduled slot position (see Fig. M-4).
2. Fix the module with the four screws.
3. Mount the cover plate again.

If the STM-16/OC-48 module shall be operated in combination with the “2488 Mbit/s Jitter Analyzer/Generator” module, both modules have to be balanced to each other.

Each STM-16/OC-48 module can be installed in each ANT-20SE without changing the software.

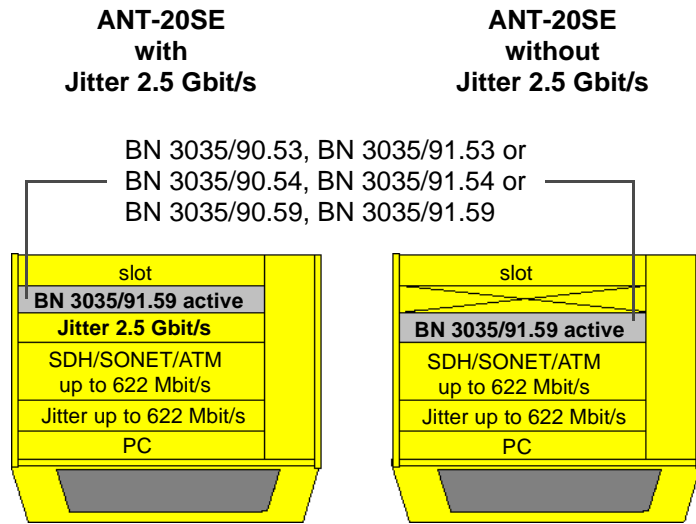

Fig. M-4 Slots for the STM-16/OC-48 modules

3.5 Installation instructions STM-64/OC-192

The STM-64/OC-192 module comprises up to four separate boards (depending on the options) that are bolted together. The PS interface (power supply interface) is used to connect to the motherboard. All parts are pre-assembled.

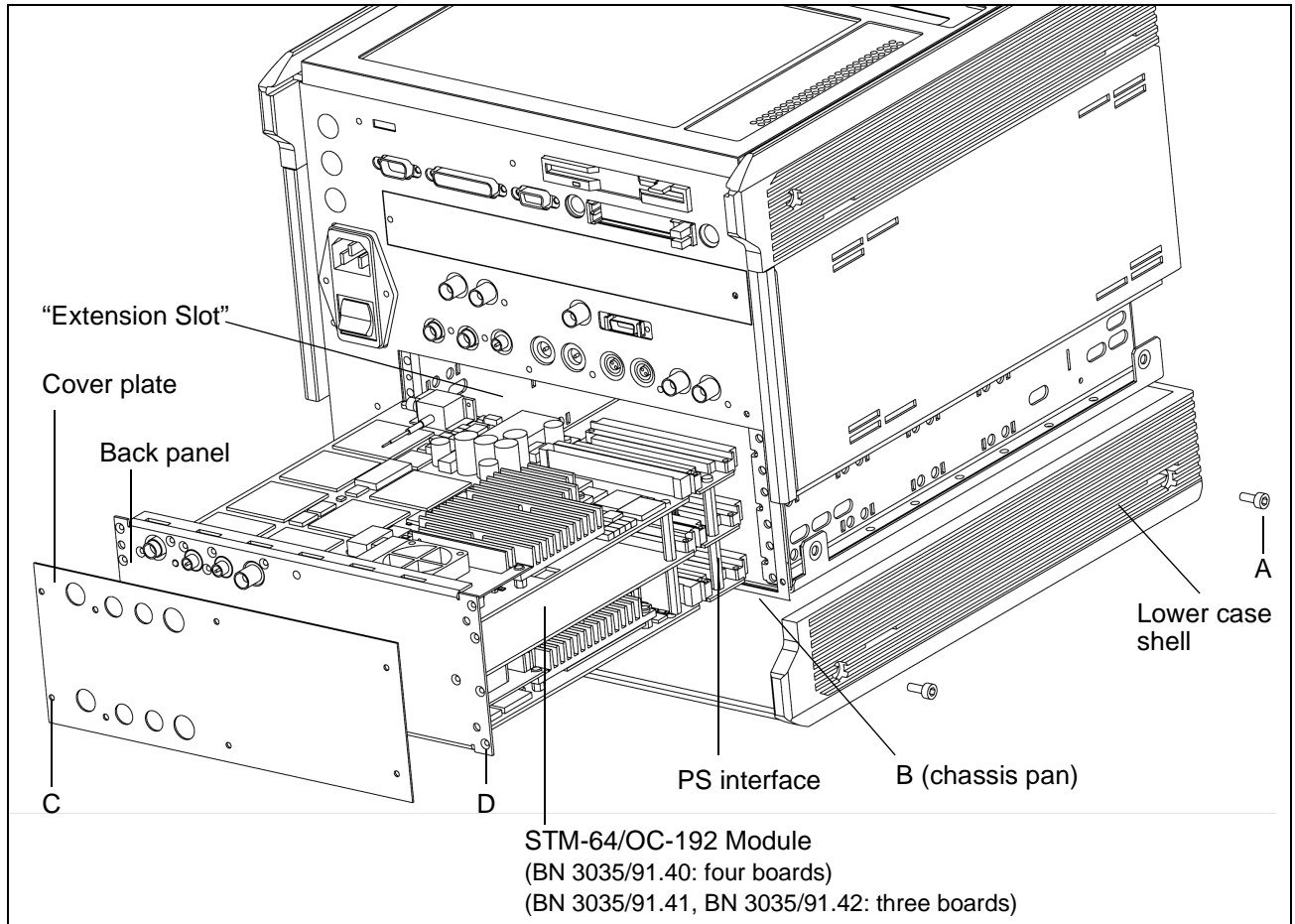

Fig. M-5 Installing the STM-64/OC-192 optical interface

Preparation

1. **Disconnect the ANT-20SE from the AC line and all test circuits.**
2. **Heed the measures for preventing electrostatic damage.**
Do not remove the STM-64/OC-192 optical interface from its package until you are ready to install it. The bag protects the interface module from electrostatic damage.
3. Remove the four screws (A) securing the lower case shell.
4. Remove the lower case shell.
5. Remove the seven countersunk screws (B) from the chassis pan.
6. Remove the three "Extension Slot" cover plates (two screws each).
7. Remove the three blanking panels (four screws each).

Installation

To install the STM-64/OC-192 optical interface, proceed as follows:

1. Open the bag containing the STM-64/OC-192 optical interface and take out the interface module.
2. Remove the pre-assembled cover plate by undoing the six screws (C).
3. Fit the interface module into the "Extension Slot".
4. Bolt the back panel of the interface module to the chassis with the eight screws (D).
5. Bolt the interface module to the chassis pan with the seven countersunk screws (B).
6. Fit the cover plate using the six screws (C).
7. Fit the lower case shell in position.
8. Bolt on the lower case shell with the four screws (A).
9. Affix the laser safety label for Class 3A (see Fig. M-7).

3.6 Affixing the laser safety warning labels

A laser safety warning label in the local language indicating the laser class must be affixed to the outside of the ANT-20SE in such a position that it is clearly visible to the user.

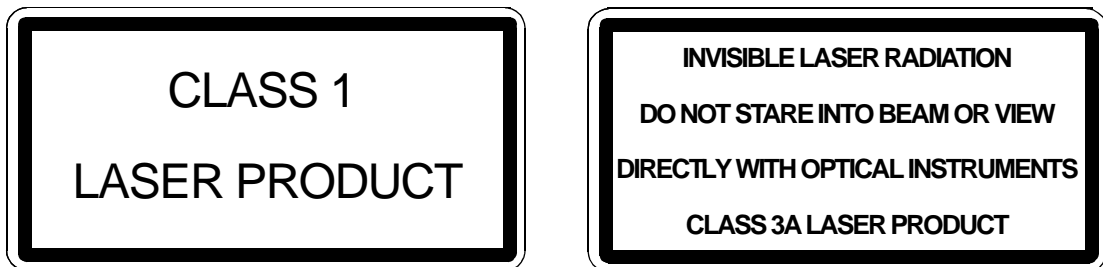

Fig. M-6 Laser class safety warning labels

We recommend that the laser safety warning label is affixed to the front panel of the ANT-20SE below socket [05] (see Fig. M-7).

Use the following laser safety warning labels:

- CLASS 1 LASER PRODUCT
for Options BN 3035/90.43 through 90.48
- CLASS 3A LASER PRODUCT
for Options BN 3035/90.53, BN 3035/90.54, BN 3035/90.59, BN 3035/91.53,
BN 3035/91.54, BN 3035/91.59, BN 3035/91.40 and BN 3035/91.41

A sheet of laser safety warning labels is included with each module.

Note: If Options in the BN 3035/90.43 through 90.48 range **and** BN 3035/90.53, BN 3035/90.54, BN 3035/90.59, BN 3035/91.53, BN 3035/91.54, BN 3035/91.59, BN 3035/91.40 or BN 3035/91.41 are both fitted, the CLASS 3A LASER PRODUCT label should be affixed. Any CLASS 1 LASER PRODUCT label already affixed to the instrument should be removed or the new label affixed over it so that it is completely concealed.

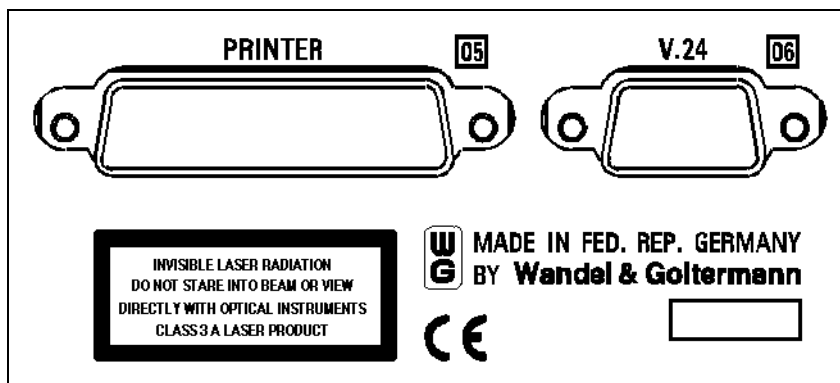

Fig. M-7 Laser safety warning label on the front panel of the ANT-20SE



Notes:



Specifications STM-0/1/4/OC-1/3/12

The numbers in square brackets [...] correspond to the numbers printed on the instrument.

Calibrated specifications are indicated by ***.

1 Generator section

1.1 Digital signal output

1.1.1 Signal output [18], optical

Connector	2.5 mm (PC)
“Fiber-to-fiber” adapter for direct connection to various 2.5 mm connector types	see list of accessories
Output level ***	0 dBm +2/-3 dBm
Reduction in output level for 2 wavelength version	< 0.5 dBm
Output signal pulse shape	to ITU-T G.957
Wavelength (switchable, depending on option)	1310 nm (1280 to 1330 nm) 1550 nm (1480 to 1580 nm)
Laser class to EN 60825-1:1994	1

The generator fulfills the requirements of ITU-T G.957, classes L1.1, L1.2, L1.3, L4.1, L4.2 and L4.3. The classes S1.1, S1.2 and S4.1 and S4.2 can be achieved by inserting an optical attenuator or the optical power splitter BN 3035/90.49.

LASER ON status display

LED is on when the laser source is active.

1.2 Clock generator and bit rates

1.2.1 Clock generation

See "Specifications" for the mainframe instrument.

1.2.2 Bit rates

The available bit rates depend on the options fitted.

STM-4, OC-12	622.08 Mbit/s
STM-1, OC-3	155.52 Mbit/s
STM-0, OC-1	51.84 Mbit/s

1.3 SDH and SONET TX signals

- Generates an STM-4 or STM-1 signal conforming to ITU-T-recommendation G.707.
- Generates an STM-0 signal conforming to ITU-RF.750-3.
- Generates an OC-12, OC-3 or OC-1 signal conforming to Bellcore recommendation GR-253.

1.3.1 STM-4 TX signal

STM-4 signal formation:

- STM-1 signal, generated internally x 4 (4 x AU-4 or 12 x AU-3)
- one STM-1 signal, generated internally (AU-4/AU-3), the other three tributaries loaded with HP-UNEQ
- one STM-1 signal, generated internally (AU-4/AU-3), the other three tributaries from the receiver
- complete STM-4 signal from receiver

1.3.2 STM-1 TX signal

STM-1 signal formation:

- STM-1 signal, generated internally
- complete STM-1 signal from receiver

1.3.3 STM-0 TX signal

STM-0 signal formation:

- STM-0 signal, generated internally
- complete STM-0 signal from receiver

1.3.4 OC-12 TX signal

OC-12 signal formation:

- STS-1 signal, generated internally x 12
- one STS-1 signal, generated internally, the other eleven tributaries loaded with UNEQ
- one STS-1 signal, generated internally, the other eleven tributaries from the receiver
- complete STS-12 from receiver
- STS-3c signal, generated internally x 4 (option BN 3035/90.70)
- one STS-3c signal, generated internally, the others loaded with UNEQ
- one STS-3c signal, generated internally, the others from the receiver

1.3.5 OC-3 TX signal

OC-3 signal formation:

- STS-3 signal, generated internally
- complete STS-3 signal from receiver

OC-3c signal formation: (option BN 3035/90.70)

- STS-3c signal, generated internally
- complete STS-3c signal from receiver

1.3.6 OC-1 TX signal

OC-1 signal formation:

- STS-1 signal, generated internally
- complete STS-1 signal from receiver

1.3.7 Scrambling

Scrambling is as per ITU-T recommendation G.707.
The scrambler can be switched on or off.

SOH byte loading

- Static bytes: All except B1, B2, H1, H2, H3
- Overhead sequence m, n, p: All except B1, B2, H1, H2, H3
- Trace Identifier: J0 (Length = 16 frames with CRC7 formation)
- Dynamic byte groups with pseudo random bit sequence PRBS11: E1, F1, E2 (single byte)
- Dynamic byte groups with pseudo random bit sequence PRBS11: D1 to D3, D4 to D12 (byte group)
- Dynamic bytes via DCC/ECC interface, Socket [21] (V.11): E1, F1, E2 (single byte)
- Dynamic byte groups via DCC/ECC interface, Socket [21] (V.11): D1 to D3, D4 to D12, K1 to K2 (byte group)

STM-1, STM-0, OC-3, OC-1 standard overhead

See separate operating manual “STM-1 mappings/STS-1 mappings”.

1.3.9 Error insertion (anomalies)

The following anomalies can be inserted in addition to those in the mainframe instrument:

Anomaly	Single	Rate	Burst m, n (frames)
B1 (STM-4, OC-12)	yes	2E-4 to 1E-10	m = 1 to 196000
B2 (STM-4, OC-12)	yes	2E-3 to 1E-10	m = 1 to 196000
MS-REI (STM-4) REI-L (OC-12)	yes	2E-3 to 1E-10	m = 1 to 196000

Table S-2 Available anomalies in addition to the mainframe instrument

The insertion of **errors** (anomalies) **or alarms** (defects) are mutually exclusive. The action selected first is active.

1.3.10 Alarm generator (defects)

The following defects can be generated in addition to those in the mainframe instrument:

Defect	Test sensor function	Test sensor thresholds	
-	On/Off	M in N	---t1--- -----t2-----
LOS (optical)	yes	M = 800 to 7200 N = 1600 to 8000	t1 = 0.1 to 60.0 s t2 = 0.2 to 600 s
LOF-622	yes	M = 1 to N - 1 N = 1 to 8000 ¹	t1 = 0.1 to 60.0 s t2 = 0.2 to 600 s
RS-TIM (STM-4) TIM-L (OC-12)	yes	-	-
MS-AIS (STM-4) AIS-L (OC-12)	yes	M = 1 to N - 1 N = 1 to 8000	t1 = 0.1 to 60.0 s t2 = 0.2 to 600 s
MS-RDI (STM-4) RDI-L (OC-12)	yes	M = 1 to N - 1 N = 1 to 8000	t1 = 0.1 to 60.0 s t2 = 0.2 to 600 s
1 Included with options 3035/90.46, 3035/90.47 and 3035/90.48			

Table S-3 Available defects in addition to the mainframe instrument

The insertion of **alarms** (defects) **or errors** (anomalies) are mutually exclusive. The action selected first is active.



1.4 Output signals for the ADM Tester

1.4.1 Optical output signal

The available bit rates depend on the options fitted.

STM-4, OC-12	622.08 Mbit/s
STM-1, OC-3	155.52 Mbit/s
STM-0, OC-1	51.84 Mbit/s

Signal structure

Frame alignment signal	n x A1, n x A2
Parity formation	B1, B2, B3
Section overhead, Transport Overhead	Standard overhead, see Sec. 1.3.8, Page S-4 and "STM-1 Mappings/STS-1 Mappings" operating manual
Pointer value	"0"
Matching of "ss" bits to	STM-x/AU-4 STM-x/AU-3 OC-x
Path overhead and payload	HP-UNEQ (all zeros)

Possible modifications

Laser is switchable	ON/OFF
Wavelength is selectable	1310 nm, 1550 nm
Scrambler is permanently	ON

- No frequency offset possible
- No overhead modifications possible
- No pointer actions

1.4.2 PDH output signal

The PDH output signal can be set as for normal operation. There are no restrictions.

2 Receiver section

2.1 Digital signal inputs

2.1.1 Signal input [17], optical

Connector 2.5 mm (PC)

“Fiber-to-fiber” adapter for direct connection to various
2.5 mm connector types see list of accessories

Input sensitivity

STM-1 / OC-3 ^{***}, STM-0 / OC-1 -8 to -28 dBm

STM-4 / OC-12 ^{***} -8 to -28 dBm

Max. permitted input level +2 dBm

Wavelength 1100 to 1580nm

The receiver meets the requirements of ITU-T G.957 classes S1.1, S1.2, S4.1, S4.2 and S4.3.

Tolerance to jitter

measured using scrambled SDH or SONET signals:

Jitter amplitude

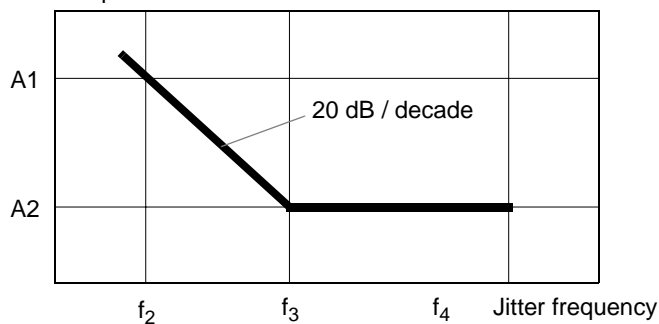

Fig. S-1 Relationship between jitter amplitude and jitter frequency

Bit rate Mbit/s	A1 UIpp	f ₂ kHz	A2 UIpp	f ₃ kHz	f ₄ kHz
51.840	1.5	2	0.15	20	500
155.520	1.5	6.5	0.15	65	1300
622.080	1.5	25	0.15	250	5000

Table S-4 Tolerance to jitter at system bit rates for the ANT-20SE



Optical signal level display

Resolution 1 dBm

Accuracy ± 1 dBm

LOS (Loss of Signal) status display

LED is on when the signal input is active but no signal is present.

Note: The high sensitivity of the optical input may cause LOF to be detected instead of LOS with some systems. This is due to incomplete blanking of the laser source (system or ANT-20SE).

One way of testing laser blanking despite this problem is to insert an additional optical attenuator in front of the input. This attenuates any residual light so that the level is below the LOS threshold.

LOS threshold < -30 dBm

2.1.2 Signal input [16], electrical

Connector unbalanced (coaxial)

Socket type SMA

Input impedance 50Ω
 ab Serie AG Eingangswiderstand für ECL-Signale vorhanden

Line code NRZ (scrambled)

Input voltage range 200 mVpp to 1 Vpp

Bit rate 155.52 Mbit/s; 622.08 Mbit/s

Tolerance to jitter

As stated in Tab. S-4, Page S-8

LOS (Loss of Signal) status display

LED is on when the signal input is active but no signal is present.

2.1.3 Clock recovery

See "Specifications" for the mainframe instrument.

2.2 SDH and SONET RX signals

- Evaluation of STM-4 or STM-1 signal conforming to ITU-T recommendation G.707.
- Evaluation of STM-0 signal conforming to ITU-RF.750-3.
- Evaluation of OC-12, OC-3 or OC-1 signal conforming to the Bellcore GR-253 standard.

2.2.1 STM-4 RX signal

STM-4 signal evaluation:

- Analysis of section overhead (SOH) and demultiplexing of one channel, further analysis in mainframe
- Analysis of section overhead (SOH) and loop-through of STM-4 signal to transmitter

2.2.2 STM-1 RX signal

STM-1 signal evaluation:

- takes place in the mainframe.

2.2.3 STM-0 RX signal

STM-0 signal evaluation:

- takes place in the mainframe.

2.2.4 OC-12 RX signal

OC-12 signal evaluation:

- Analysis of transport overhead (TOH) and demultiplexing of one channel, further analysis in mainframe
- Analysis of transport overhead (TOH) and loop-through of OC-12 signal to transmitter

2.2.5 OC-3 RX signal

OC-3 signal evaluation:

- takes place in the mainframe.

OC-3c signal evaluation:

- takes place in the mainframe.

2.2.6 OC-1 RX signal

OC-1 signal evaluation:

- takes place in the mainframe.

2.2.7 Descrambling

Descrambling is as per ITU-T recommendation G.707.
The descrambler can be switched on or off.

Tip: In the case of unscrambled input signals make sure that there are no longer sequences with HIGH logical or LOW logical bits in the data stream.

2.3 Measurement modes

2.3.1 Alarm detection (defects)

The following alarms can be evaluated and displayed in addition to the alarm detection functions given in the mainframe instrument:

Defect	LED
LOS (optical)	LOS
LOF-622	LOF/OOF
RS-TIM (STM-4) TIM-L (OC-12)	-
MS-AIS (STM-4) AIS-L (OC-12)	MS-AIS/AIS-L
MS-RDI (STM-4) RDI-L (OC-12)	MS-RDI/RDI-L

Table S-5 LED displays for additional defects

2.3.2 Error measurements (anomalies)

The following anomalies can be evaluated and displayed in addition to the error measurements given in the mainframe instrument:

Anomaly	LED
OOF-622	LOF/OOF
B1(STM-4, OC-12)	B1/B2
B2 (STM-4, OC-12)	B1/B2
MS-REI (STM-4) REI-L (OC-12)	-

Table S-6 LED displays for additional anomalies

Evaluation and display of B2 errors (STM-4, OC-12) refers to all test channels taken together.

2.3.3 Section overhead (SOH) and transport overhead (TOH) evaluation

Display

- complete SOH, TOH hexadecimal
(four channel-oriented partial SOHs/TOHs)
- Trace Identifier J0 (STM-4/OC-12) ASCII, plain text

Evaluation

Bit error measurement

- bytes with pseudo random bit sequence PRBS11 E1, F1, E2 (single byte)
- byte groups with pseudo random bit sequence PRBS11 D1 to D3, D4 to D12
(byte group)

Output

The overhead channels are output

- in bytes via DCC/ECC interface, socket [21] (V.11) E1, F1, E2 (single byte)
- in byte groups via DCC/ECC interface, socket [21] (V.11) D1 to D3, D4 to D12, K1 to K2
(byte group)

3 Optical power splitter BN 3035/90.49

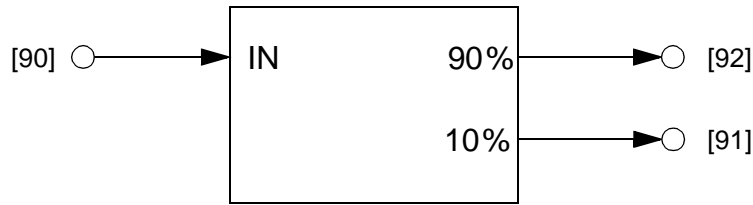

Fig. S-2 Optical Power Splitter

3.1 Wavelength ranges

“1310 nm” 1260 to 1360 nm

“1550 nm” 1500 to 1600 nm

3.2 Attenuation

Between “IN” [90] and “90%” [92]. 1.0 dB (typically),
 < 1.6 dB

Between “IN” [90] and “10%” [91]. 10.5 dB (typically),
 8.8 to 12.0 dB

4 Drop&Insert / Through Mode / Block&Replace

Option: BN 3035/90.20

4.1 Functions

This option provides the following functions for all mapping options fitted to the ANT-20SE.

Drop&Insert

Generator and receiver operate independently as mapper and demapper. The signal from a selected channel is dropped from the receive signal and output to a connector. An external signal is inserted into the transmit signal.

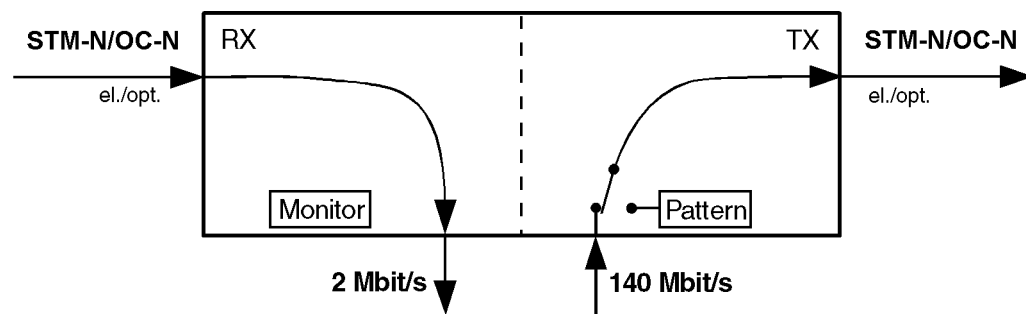

Fig. S-3 Drop&Insert: Generator and receiver operate independently

An unbalanced digital input and output are provided on the mainframe instrument for dropping and for inserting tributary signals (see Sec. 4.3.1, Page S-20 and Sec. 4.2.1, Page S-19).

The mainframe instrument is also equipped with a balanced output [13] and input [12] for dropping and for inserting tributary signals via balanced interfaces.

Through Mode

The received signal is looped through the ANT-20SE and re-transmitted by the generator. One tributary signal can be output (dropped).

The ANT-20SE can also operate in Through Mode as a signal monitor without affecting the signal content.

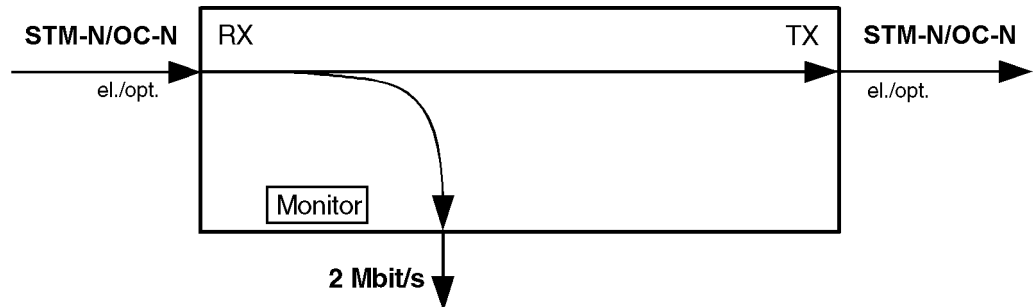

Fig. S-4 Through Mode: Generator and receiver coupled

In conjunction with the options “PDH MUX/DEMUX” and “M13 MUX/DEMUX”, BN 3035/90.30 to BN 3035/90.32, the ANT-20SE provides access to the tributary channels within the MUX/DEMUX chain. This also applies if the PDH signal is transmitted in a container.

The looped-through signal can also be jittered using the Jitter Generator options (Jitter Generator up to 155 or 622 Mbit/s, BN 3035/90.60 to 61). This function is available for all bit rates fitted to the instrument.

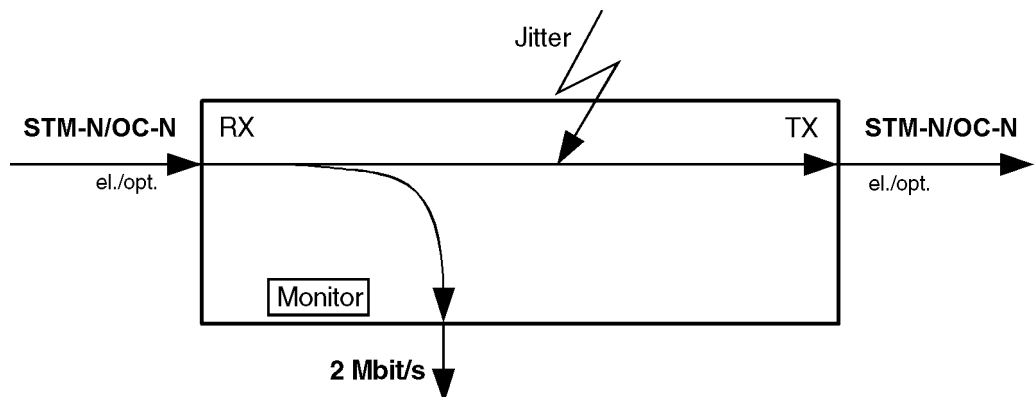

Fig. S-5 Through Mode: Adding jitter to the looped-through signal

In Through Mode, anomalies can be inserted in the SOH/TOH or the SOH/TOH bytes can be manipulated.

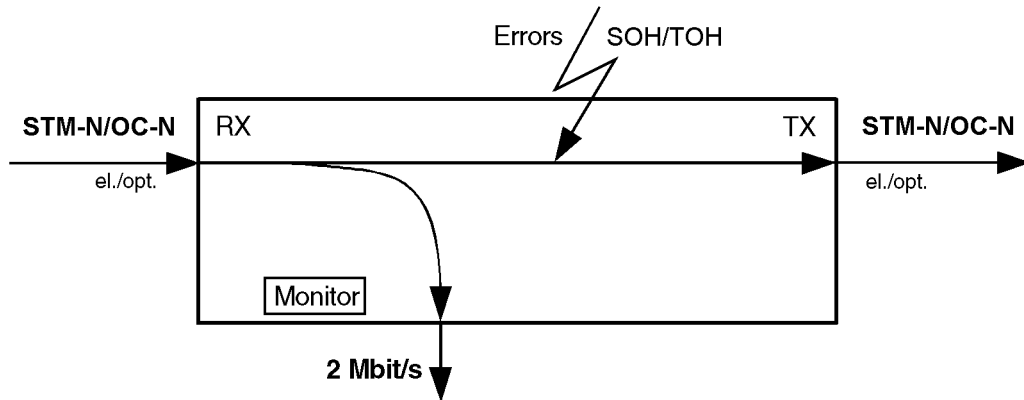

Fig. S-6 Through Mode: Inserting errors in the SOH/TOH

Block&Replace

Only possible with SDH C4 and C3 mapping and SONET STS3c and STS1 SPE mapping.

The transmitter and receiver are coupled. The received signal is looped through from the receiver to the transmitter. The ANT-20SE is used as a test channel monitor on the receive side. The test channel is reconstructed on the transmit side.

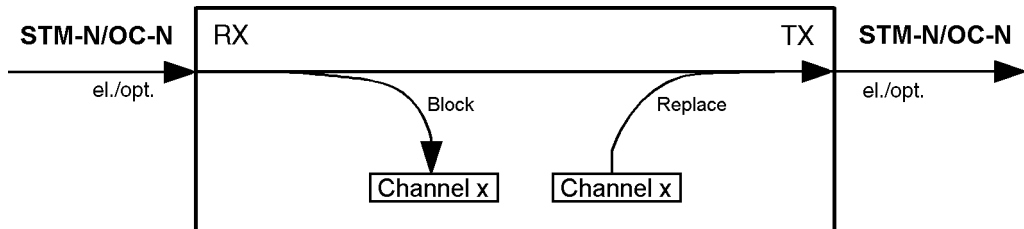

Fig. S-7 Block&Replace: Transmitter and receiver coupled

Jitter can be superimposed on the received signal in through mode when the "Jitter Generator up to 155 Mbit/s" or "Jitter generator up to 622 Mbit/s" options BN 3035/90.60 to 61 are used. This applies to all bit rates available in the instrument.

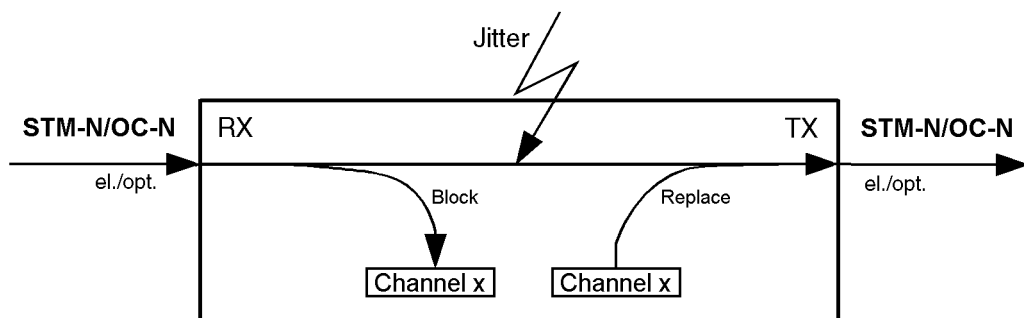

Fig. S-8 Block&Replace: Jittered through signal

Anomalies can be inserted in the SOH/TOH or the bytes manipulated in Block&Replace mode.

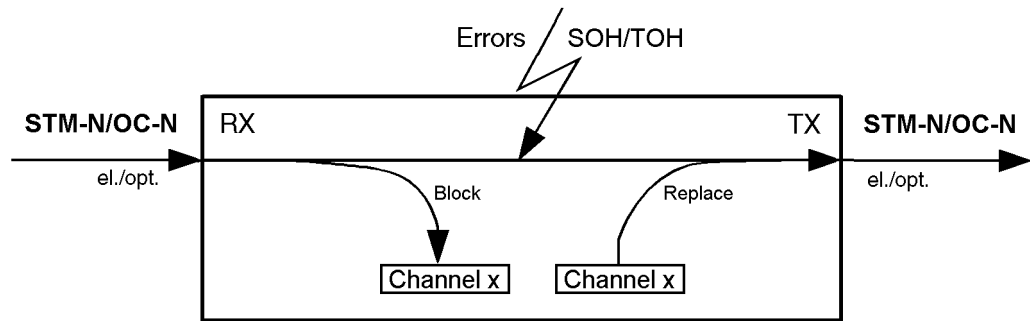

Fig. S-9 Block&Replace: Error insertion into the SOH/TOH

4.1.1 Clock generator

Drop&Insert

As specified in the "Specifications" of the mainframe instrument.

Through Mode

In Through Mode, clock generation is always derived from the receive signal clock. No signal offset is possible in this operating mode (see also the "Specifications" of the mainframe instrument).

4.1.2 Overhead generator

Drop&Insert

As specified in Sec. 1.3.8, Page S-4.

Through Mode

The "From Rx" function can be set in addition to the functions described in Sec. 1.3.8, Page S-4 for all bytes except bytes B1, B2 and M1.

4.1.3 Anomaly insertion

Drop&Insert

As specified in Sec. 1.3.9, Page S-5.

Through Mode

Anomaly insertion in bytes B1, B2 and MS-REI/REI-L. Insertion limits are specified in Sec. 1.3.9, Page S-5.

4.1.4 Defect generation

Drop & Insert

As specified in Sec. 1.3.10, Page S-6.

Through Mode

No direct defect generation is possible.

Tip: Alarms (defects) in the SOH/TOH can be generated by manipulating the SOH bytes.

4.1.5 Measurements

There are no restrictions on measurements. See Sec. 2.3, Page S-11.

4.2 Signal outputs

4.2.1 AUXILIARY signal output [11], electrical

Connector	unbalanced, (coaxial)
Socket type	BNC
Output impedance	75 Ω
Max. permitted peak spurious input voltage	± 5 V

Interface	Bit rate (Mbit/s)	Line code	Output voltage
E4	139.264	CMI	± 0.5 V
DS3	44.736	B3ZS	± 1.0 V
E3	34.368	HDB3	
E2	8.448	HDB3	± 2.37 V
E1	2.048	HDB3	
DS1	1.544	B8ZS	
The bit rates depend on the mapping options fitted.			

Table S-7 Specifications of the AUXILIARY signal output [11], electrical

4.2.2 LINE/AUXILIARY signal output [13], electrical

Connector	balanced
Socket type	Lemo SA (Bantam)
Output impedance	
2.048 Mbit/s	120 Ω
1.544 Mbit/s	100 Ω
Max. permitted peak spurious input voltage	± 5 V

Interface	Bit rate (Mbit/s)	Line code	Output voltage
E1	2.048	HDB3	± 3.0 V
DS1	1.544	B8ZS	DSX-1 compatible
The bit rates depend on the mapping options fitted.			

Table S-8 Specifications of the LINE/AUXILIARY signal output [13], electrical

The balanced output is used both as "LINE" and as "AUXILIARY" output.

4.3 Signal inputs

4.3.1 AUXILIARY signal input [10], electrical

Connector	unbalanced, (coaxial)
Socket type	BNC
Input impedance	75 Ω
Max. permitted frequency offset	± 500 ppm
Input voltage range	0 dB attenuation referred to nominal level
Max. permitted peak input voltage	± 5 V

Interface	Bit rate (Mbit/s)	Line code	Input voltage
E4	139.264	CMI	1.0 V ± 10 %
DS3	44.736	B3ZS	1.0 V ± 10 %
E3	34.368	HDB3	
E2	8.448	HDB3	2.37 V ± 10 %
E1	2.048	HDB3	
DS1	1.544	B8ZS	

The bit rates depend on the mapping options fitted.

Table S-9 Specifications of the AUXILIARY signal input [10], electrical

LOS (Loss of Signal) status display

LED lights up if the signal input is active but no signal is present.

4.3.2 LINE/AUXILIARY signal input [12], electrical

Connector	balanced
Socket type	Lemo SA (Bantam)
Input impedance	
2.048 Mbit/s	120 Ω
1.544 Mbit/s	100 Ω
Max. permitted frequency offset	± 500 ppm
Max. number of consecutive zeros for line code = AMI	15
Max. permitted peak input voltage	± 5 V



Interface	Bit rate (Mbit/s)	Line code	Input voltage
E1	2.048	HDB3	3.0 V \pm 10 %
DS1	1.544	B8ZS	

The bit rates depend on the mapping options fitted.

Table S-10 Specifications of the LINE/AUXILIARY signal input [12], electrical

LOS (Loss of Signal) status display

LED lights up if the signal input is active but no signal is present.

The balanced input is used both as "LINE" and as "AUXILIARY" input.



Notes:

Specifications STM-16/OC-48

The numbers in square brackets [...] correspond to the numbers printed on the instrument.

Calibrated specifications are indicated by ***.

1 Generator section

1.1 Digital signal output

1.1.1 Signal output [47], optical

Connector 2.5 mm (PC)

“Fiber-to-fiber” adapter for direct connection to various
2.5 mm connector types see list of accessories

Output level *** 0 dBm +0/-2 dBm

Output signal pulse shape to ITU-T G.957

Wavelength (switchable, depending on option) 1310 nm (1285 to 1340 nm)
1550 nm (1520 to 1600 nm)

Laser class to EN 60825-1:1994,

Normal operation 1

Fault condition 3A

The generator fulfils the requirements of ITU-T G.957, classes S16.2, L16.2, L16.3 or S16.1, L16.1.

LASER ON status display

LED is on when the laser source is active.

1.1.2 Signal output [46], electrical

Connector	unbalanced (coaxial)
Socket	SMA
Signal output impedance	50 Ω
Line code	NRZ (scrambled)
Output voltage	≥ 500 mVpp
Bit rate	2488.32 Mbit/s

1.2 Clock generator and bit rates

1.2.1 Clock generation internal

See “Specifications” for the mainframe instrument.

Permissible clock offset	±50 ppm
------------------------------------	---------

1.2.2 Clock generation external [45]

For feeding in a jitter-modulated clock signal that must be derived from the base module clock.

Clock frequency	2488.32 Mbit/s
Connector	unbalanced (coaxial)
Socket	SMA
Clock input impedance	50 Ω
Input voltage range300 mVpp to 1 Vpp

1.2.3 Bit rate

STM-16, OC-48	2488.32 Mbit/s
-------------------------	----------------

1.2.4 Clock output [41]

For the Generator clock

Frequency	2488.32 MHz
Connector	unbalanced (coaxial)
Socket	SMA
Output impedance	50 Ω
Output voltage	≥ 300 mVpp

1.3 SDH and SONET TX signals

- Generates an STM-16 signal conforming to ITU-T recommendation G.707.
- Generates an OC-48 signal conforming to the Bellcore-GR-253 and ANSI T1.105 standards.

1.3.1 STM-16 TX signal

STM-16 signal formation:

- STM-1 signal, generated internally x 16 (16 x AU-4 or 48 x AU-3)
- one STM-1 signal, generated internally (AU-4/AU-3), the other 15 tributaries loaded with HP-UNEQ
- one STM-1 signal, generated internally (AU-4/AU-3), the other 15 tributaries from the receiver

STM-16c signal formation:

- complete STM-16 signal from receiver

1.3.2 OC-48 TX signal

OC-48 signal formation:

- STS-1 signals, generated internally and STS-1 signals loaded with UNEQ
- STS-3c signal, generated internally x 16
- one STS-3c signal, generated internally, the other 15 tributaries loaded with UNEQ
- STS-1 signals generated internally, the other 47 tributaries loaded with UNEQ
- STS-48 signal from receiver
- one STS-3c signal, generated internally, the other 15 tributaries from the receiver

1.3.3 Scrambling

Scrambling is as per ITU-T recommendation G.707.
The scrambler cannot be switched off.



SOH, TOH		SOH, TOH																					
		#1	#2	#3	#4	#5	#6	#7	#8	#9	#10	#11	#12	#13	#14	#15	#16	#1	...	#1	...	#16	
1	A1 F6	A1 F6	A1 F6	A1 F6	A1 F6	A1 F6	A1 F6	A1 F6	A1 F6	A1 F6	A1 F6	A1 F6	A1 F6	A1 F6	A1 F6	A1 F6	A1 F6	A1 F6	A1 F6	A1 F6	A1 F6	A1 F6	A1 F6
2	B1 XX	B1 XX	B1 XX	B1 XX	B1 XX	B1 XX	B1 XX	B1 XX	B1 XX	B1 XX	B1 XX	B1 XX	B1 XX	B1 XX	B1 XX	B1 XX	B1 XX	B1 XX	B1 XX	B1 XX	B1 XX	B1 XX	B1 XX
3	D1	D1	D1	D1	D1	D1	D1	D1	D1	D1	D1	D1	D1	D1	D1	D1	D1	D1	D1	D1	D1	D1	D1
4a	H1 68	H1 68	H1 68	H1 68	H1 68	H1 68	H1 68	H1 68	H1 68	H1 68	H1 68	H1 68	H1 68	H1 68	H1 68	H1 68	H1 68	H1 68	H1 68	H1 68	H1 68	H1 68	H1 68
4b	H1 68	H1 68	H1 68	H1 68	H1 68	H1 68	H1 68	H1 68	H1 68	H1 68	H1 68	H1 68	H1 68	H1 68	H1 68	H1 68	H1 68	H1 68	H1 68	H1 68	H1 68	H1 68	H1 68
4c	H1 60	H1 60	H1 60	H1 60	H1 60	H1 60	H1 60	H1 60	H1 60	H1 60	H1 60	H1 60	H1 60	H1 60	H1 60	H1 60	H1 60	H1 60	H1 60	H1 60	H1 60	H1 60	H1 60
4d	H1 60	H1 60	H1 60	H1 60	H1 60	H1 60	H1 60	H1 60	H1 60	H1 60	H1 60	H1 60	H1 60	H1 60	H1 60	H1 60	H1 60	H1 60	H1 60	H1 60	H1 60	H1 60	H1 60
5	B2 XX	B2 XX	B2 XX	B2 XX	B2 XX	B2 XX	B2 XX	B2 XX	B2 XX	B2 XX	B2 XX	B2 XX	B2 XX	B2 XX	B2 XX	B2 XX	B2 XX	B2 XX	B2 XX	B2 XX	B2 XX	B2 XX	B2 XX
6	D4	D4	D4	D4	D4	D4	D4	D4	D4	D4	D4	D4	D4	D4	D4	D4	D4	D4	D4	D4	D4	D4	D4
7	D7	D7	D7	D7	D7	D7	D7	D7	D7	D7	D7	D7	D7	D7	D7	D7	D7	D7	D7	D7	D7	D7	D7
8	D10	D10	D10	D10	D10	D10	D10	D10	D10	D10	D10	D10	D10	D10	D10	D10	D10	D10	D10	D10	D10	D10	D10
9	S1 00	S1 00	S1 00	S1 00	S1 00	S1 00	S1 00	S1 00	S1 00	S1 00	S1 00	S1 00	S1 00	S1 00	S1 00	S1 00	S1 00	S1 00	S1 00	S1 00	S1 00	S1 00	S1 00

Table S-1 SOH, TOH contents; STM-16, OC-48

1.3.5 Error insertion (anomalies)

The following anomalies can be inserted in addition to those in the mainframe instrument:

Anomaly	Single	Rate	Burst m, n (frames)
B1 (STM-16, OC-48)	yes	1E-8 to 2E-5	m = 1 to 196000
B2 (STM-16, OC-48)	yes	1E-8 to 1E-3	m = 1 to 196000
MS-REI (STM-16) REI-L (OC-48)	yes	1E-8 to 1E-3	m = 1 to 196000

Table S-2 Available anomalies in addition to the mainframe instrument

The insertion of **errors** (anomalies) **or alarms** (defects) are mutually exclusive. The action selected first is active.

1.3.6 Alarm generator (defects)

The following defects can be generated in addition to those in the mainframe instrument:

Defect	Test sensor function	Test sensor thresholds	
		M in N	----t1---- ----t2-----
-	On/Off	M in N	----t1---- ----t2-----
LOS (optical)	yes	M = 800 to 7200 N = 1600 to 8000	t1 = 0.1 to 60.0 s t2 = 0.2 to 600 s
LOF-2488	yes	M = 1 to N - 1 N = 1 to 8000	t1 = 0.1 to 60.0 s t2 = 0.2 to 600 s
RS-TIM (STM-16) TIM-L (OC-48)	yes	-	-
MS-AIS (STM-16) AIS-L (OC-48)	yes	M = 1 to N - 1 N = 1 to 8000	t1 = 0.1 to 60.0 s t2 = 0.2 to 600 s
MS-RDI (STM-16) RDI-L (OC-48)	yes	M = 1 to N - 1 N = 1 to 8000	t1 = 0.1 to 60.0 s t2 = 0.2 to 600 s

Table S-3 Available defects in addition to the mainframe instrument

The insertion of **alarms** (defects) **or errors** (anomalies) are mutually exclusive. The action selected first is active.



1.4 Output signals for the ADM Tester

1.4.1 Optical output signal

STM-16, OC-48 2488.32 Mbit/s

Signal structure

Frame alignment signal 48 x A1, 48 x A2

Parity formation B1, B2, B3

Section overhead, transport overhead Standard overhead,
see Sec. 1.3.4, Page S-26

Pointer value "0"

Matching of "ss" bits to STM-x/AU-4
STM-x/AU-3
OC-x

Path overhead and payload HP-UNEQ (all zeros)

Possible modifications

Laser is switchable ON/OFF

Switchable wavelength (depending on option fitted) 1310 nm or 1550 nm

Scrambler is permanently ON

- No frequency offset possible
- No overhead modifications possible
- No pointer actions

1.4.2 PDH output signal

The PDH output signal can be set as for normal operation. There are no restrictions.

2 Receiver section

2.1 Digital signal inputs

2.1.1 Signal input [44], optical



Caution

Destruction of input [44]

The maximum input level of -8 dBm must not be exceeded. Otherwise, the optical input can be destroyed.

⇒ Insert an optical attenuator in any case:

- for RX - TX loop operation
- for higher input levels

Connector2.5 mm (PC)

“Fiber-to-fiber” adapter for direct connection to various
2.5 mm connector types see list of accessories

Input sensitivity
STM-16 / OC-48 *** -8 to -28 dBm

Max. permitted input level -8 dBm

Wavelength1100 to 1600 nm

The receiver meets the requirements of ITU-T G.957 classes S16.2, L16.2, L16.3 or S16.1 and L16.1.

Optical signal level display

Resolution 1 dBm

Accuracy ±3 dB

LOS (Loss of Signal) status display

LED is on when the signal input is active but no signal is present.

LOS threshold < -30 dBm



2.1.2 Signal input [43], electrical

Connector	unbalanced (coaxial)
Socket type	SMA
Input impedance	50 Ω
Line code	NRZ (scrambled)
Input voltage range	300 mVpp to 1Vpp
Bit rate	2488.32 Mbit/s

LOS (Loss of Signal) status display

LED is on when the signal input is active but no signal is present.

2.1.3 Clock output [42]

For the recovered receive clock

Frequency	2488.32 MHz
Connector	unbalanced (coaxial)
Socket	SMA
Output impedance	50 Ω
Output voltage	≥ 100 mVpp

2.2 SDH and SONET RX signals

- Evaluation of STM-16 signal conforming to ITU-T recommendation G.707.
- Evaluation of OC-48 signal conforming to Bellcore GR-253 and ANSI T1.105 standards.

2.2.1 STM-16 RX signal

STM-16 signal evaluation:

- Analysis of SOH and demultiplexing of one channel, further analysis in mainframe
- Analysis of SOH and loop-through of STM-16 signal to transmitter

2.2.2 OC-48 RX signal

OC-48 signal evaluation:

- Analysis of TOH and demultiplexing of one channel, further analysis in mainframe
- Analysis of TOH and loop-through of OC-48 signal to transmitter

2.2.3 Descrambling

Descrambling is as per ITU-T recommendation G.707.
The descrambler cannot be switched off.

2.3 Measurement modes

2.3.1 Alarm detection (defects)

The following alarms can be evaluated and displayed in addition to the alarm detection functions given in the mainframe instrument:

Defect	LED
LOS (optical)	LOS
LOF-2488	LOF/OOF
RS-TIM (STM-16) TIM-L (OC-48)	-
MS-AIS (STM-16) AIS-L (OC-48)	MS-AIS/AIS-L
MS-RDI (STM-16) RDI-L (OC-48)	MS-RDI/RDI-L

Table S-4 LED displays for additional defects

2.3.2 Error measurements (anomalies)

The following anomalies can be evaluated and displayed in addition to the error measurements given in the mainframe instrument:

Anomaly	LED
OOF-2488	LOF/OOF
B1 (STM-16, OC-48)	B1/B2
B2 (STM-16, OC-48)	B1/B2
MS-REI (STM-16) REI-L (OC-48)	-

Table S-5 LED displays for additional anomalies

Evaluation and display of B2 errors (STM-16, OC-48) refers to all test channels taken together.

2.3.3 Section overhead (SOH) #1, Transport overhead (TOH) #1 evaluation

Display

- SOH #1, TOH #1 hexadecimal
Except: A1, A2, B1, B2, H1 to H3
- Trace Identifier J0 (STM-16, OC-48) ASCII, plain text

Evaluation

Bit error measurement

- With PRBS11 pseudo-random sequence
(only if channel #1 of the STM-N-/OC signal is selected): D1 to D3, D4 to D12 (byte group)

Output

The overhead channels are output

- in bytes via DCC/ECC interface, socket [40] (V.11): E1, F1, E2 (single byte)
- in byte groups via DCC/ECC interface, socket [40] (V.11): D1 to D3, D4 to D12, K1 to K2 (byte group)

3 Optical power splitter BN 3035/90.49

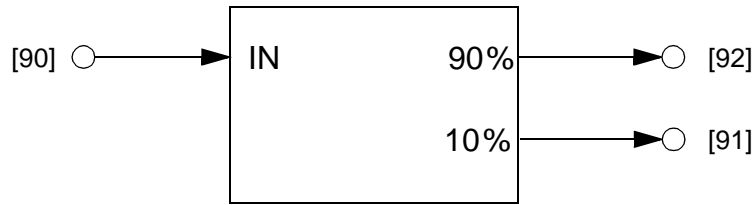

Fig. S-1 Optical Power Splitter

3.1 Wavelength ranges

"1310 nm"	1260 to 1360 nm
"1550 nm"	1500 to 1600 nm

3.2 Attenuation

Between "IN" [90] and "90%" [92].	1.0 dB (typically), < 1.6 dB
Between "IN" [90] and "10%" [91].	10.5 dB (typically), 8.8 to 12.0 dB

4 Drop&Insert / Through Mode

Option: BN 3035/90.20

4.1 Functions

This option provides the following functions for all mapping options fitted to the ANT-20SE.

Drop&Insert

Generator and receiver operate independently as mapper and demapper. The signal from a selected channel is dropped from the receive signal and output to a connector. An external signal is inserted into the transmit signal.

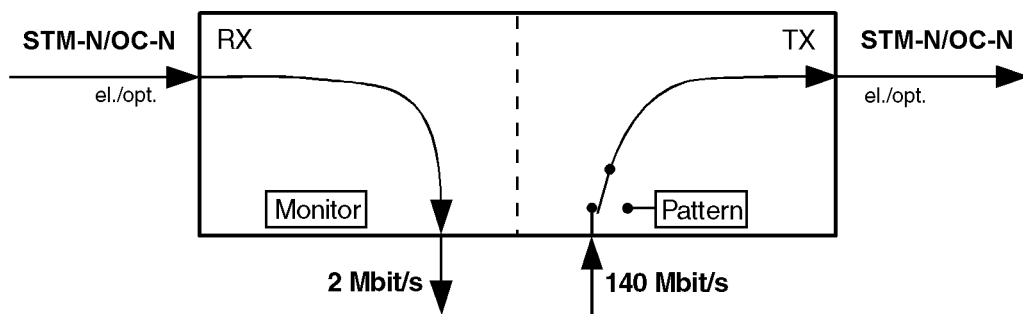

Fig. S-2 Drop&Insert: Generator and receiver operate independently

An unbalanced digital input and output are provided on the mainframe instrument for dropping and for inserting tributary signals (see Sec. 4.3.1, Page S-40 and Sec. 4.2.1, Page S-39).

The mainframe instrument is also equipped with a balanced output [13] and input [12] for dropping and for inserting tributary signals via balanced interfaces.

Through Mode

The received signal is looped through the ANT-20SE and re-transmitted by the generator. One tributary signal can be output (dropped).

The ANT-20SE can also operate in Through Mode as a signal monitor without affecting the signal content.

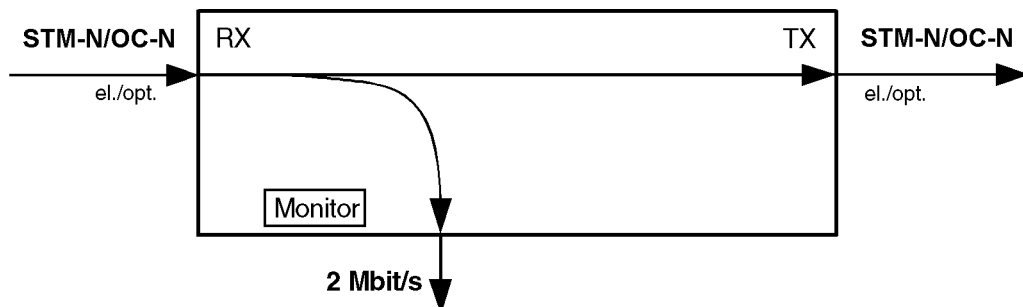

Fig. S-3 Through Mode: Generator and receiver coupled

In conjunction with the options “PDH MUX/DEMUX” and “M13 MUX/DEMUX”, BN 3035/90.30 to BN 3035/90.32, the ANT-20SE provides access to the tributary channels within the MUX/ DEMUX chain. This also applies if the PDH signal is transmitted in a container.

The looped-through signal can also be jittered using the Jitter Generator options (Jitter Generator up to 155 or 622 Mbit/s, BN 3035/90.60 to 61). This function is available for all bit rates fitted to the instrument.

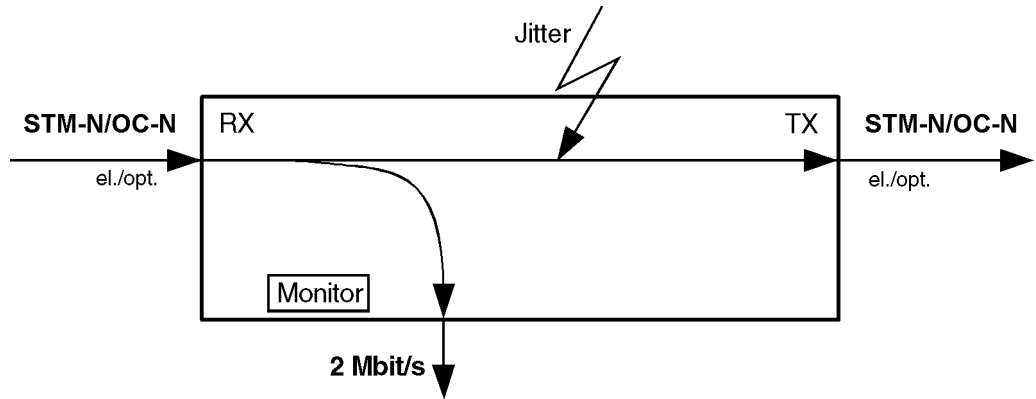

Fig. S-4 Through Mode: Adding jitter to the looped-through signal

In Through Mode, anomalies can be inserted in the SOH/TOH or the SOH/TOH bytes can be manipulated.

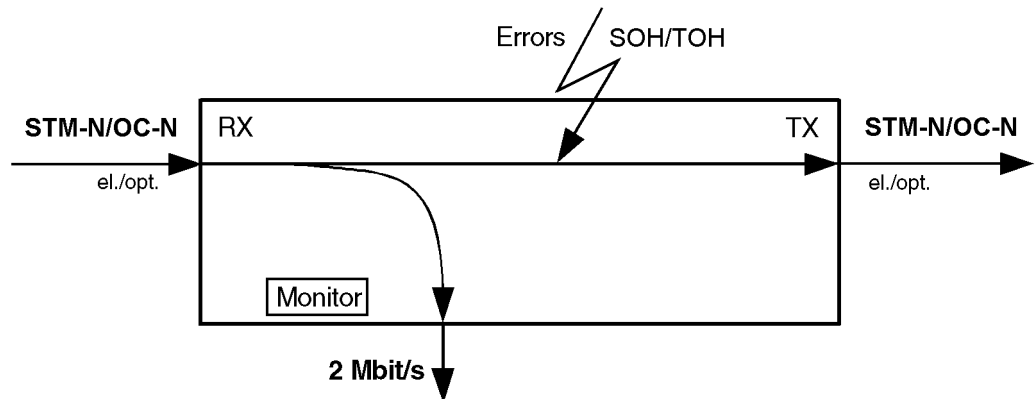

Fig. S-5 Through Mode: Inserting errors in the SOH/TOH

4.1.1 Clock generator

Drop&Insert

As specified in the “Specifications” of the mainframe instrument.

Through Mode

In Through Mode, clock generation is always derived from the receive signal clock. No signal offset is possible in this operating mode (see also the “Specifications” of the mainframe instrument).

4.1.2 Overhead generator

Drop&Insert

As specified in Sec. 1.3.4, Page S-26.

Through Mode

The “From Rx” function can be set in addition to the functions described in Sec. 1.3.4, Page S-26 for all bytes except bytes B1, B2 and M1.

4.1.3 Anomaly insertion

Drop&Insert

As specified in Sec. 1.3.5, Page S-28.

Through Mode

Anomaly insertion in bytes B1, B2 and MS-REI/REI-L. Insertion limits are specified in Sec. 1.3.5, Page S-28.

4.1.4 Defect generation

Drop&Insert

As specified in Sec. 1.3.6, Page S-28.

Through Mode

No direct defect generation is possible.

Tip: Alarms (defects) in the SOH can be generated by manipulating the SOH bytes.

4.1.5 Measurements

There are no restrictions on measurements (see Sec. 2.3, Page S-33).

4.2 Signal outputs

4.2.1 Signal output [15], electrical

Connector	unbalanced, (coaxial)
Socket type	BNC
Output impedance	75 Ω
Max. permitted peak spurious input voltage	± 5 V

Interface	Bit rate (Mbit/s)	Line code	Output voltage
E4	139.264	CMI	± 0.5 V
DS3	44.736	B3ZS	± 1.0 V
E3	34.368	HDB3	
E2	8.448	HDB3	± 2.37 V
E1	2.048	HDB3	
DS1	1.544	B8ZS	
The bit rates depend on the mapping options fitted.			

Table S-6 Specifications of the signal output [15], electrical

4.2.2 LINE/AUXILIARY signal output [13], electrical

Connector	balanced
Socket type	Lemo SA (Bantam)
Output impedance	
2.048 Mbit/s	120 Ω
1.544 Mbit/s	100 Ω
Max. permitted peak spurious input voltage	± 5 V

Interface	Bit rate (Mbit/s)	Line code	Output voltage
E1	2.048	HDB3	± 3.0 V
DS1	1.544	B8ZS	DSX-1 compatible
The bit rates depend on the mapping options fitted.			

Table S-7 Specifications of the LINE/AUXILIARY signal output [13], electrical

The balanced output is used both as "LINE" and as "AUXILIARY" output.

4.3 Signal inputs

4.3.1 AUXILIARY signal input [10], electrical

Connector	unbalanced, (coaxial)
Socket type	BNC
Input impedance	75 Ω
Max. permitted frequency offset	± 500 ppm
Input voltage range	0 dB attenuation referred to nominal level
Max. permitted peak input voltage	± 5 V

Interface	Bit rate (Mbit/s)	Line code	Input voltage
E4	139.264	CMI	1.0 V ± 10 %
DS3	44.736	B3ZS	1.0 V ± 10 %
E3	34.368	HDB3	
E2	8.448	HDB3	2.37 V ± 10 %
E1	2.048	HDB3	
DS1	1.544	B8ZS	
The bit rates depend on the mapping options fitted.			

Table S-8 Specifications of the AUXILIARY signal input [10], electrical

LOS (Loss of Signal) status display

LED lights up if the signal input is active but no signal is present.



4.3.2 LINE/AUXILIARY signal input [12], electrical

Connector	balanced
Socket type	Lemo SA (Bantam)
Input impedance	
2.048 Mbit/s	120 Ω
1.544 Mbit/s	100 Ω
Max. permitted frequency offset	± 500 ppm
Max. number of consecutive zeros for line code = AMI	15
Max. permitted peak input voltage	± 5 V

Interface	Bit rate (Mbit/s)	Line code	Input voltage
E1	2.048	HDB3	3.0 V ± 10 %
DS1	1.544	B8ZS	
The bit rates depend on the mapping options fitted.			

Table S-9 Specifications of the LINE/AUXILIARY signal input [12], electrical

LOS (Loss of Signal) status display

LED lights up if the signal input is active but no signal is present.

The balanced input is used both as "LINE" and as "AUXILIARY" input.

5 Additions for SOH

These additions affect the following options:

- BN 3035/91.53
- BN 3035/91.54
- BN 3035/91.59

5.1 Generator section

5.1.1 Overhead generator

5.1.1.1 Section overhead (SOH), Transport overhead (TOH)

Section Overhead STM-16, OC-48

See Tab. S-11, Page S-44.

Settings can be made in the entire SOH, TOH excluding the B1 and B2 bytes and the complete pointer line (H1, H2, H3).

XX: Inserted by parity formation (B1, B2)

Line 4a: SDH pointers (AU-4)

Line 4b: SDH pointers (AU-3)

Line 4c: SONET pointers (STS-1 SPE)

Line 4d: SONET pointers (STS-3c)

Line 4e: SDH pointers (AU-4, VC-4-4c)

Line 4f: SONET pointers (STS-12c SPE)

Line 4g: SDH pointers (AU-4, VC-4-16c)

Line 4h: SONET pointers (STS-48c SPE)

Line 9: Z1 and Z2 are used for SONET only

H1 and H2 depend on the pointer address setting (pointer address = 0 is shown). H3 depends on whether a pointer action takes place or not.

Overhead byte loading

- Static bytes: All except B1, B2, H1, H2, H3
- Overhead sequence m, n, p: All except B1, B2, H1, H2, H3
- Trace Identifier: J0 (Length = 16 frames with CRC7 formation)
- Dynamic byte groups with pseudo random bit sequence PRBS11: E1, F1, E2
D1 to D3, D4 to D12 (byte group)
- Dynamic via DCC/ECC interface socket [21] (V.11): E1, F1, E2 (single byte)
- Dynamic via DCC/ECC interface socket [21] (V.11): D1 to D3, D4 to D12, K1 to K2 (byte group)

5.1.2 Error insertion (anomalies)

The following anomalies can be inserted in addition to those in the mainframe instrument:

Anomaly	Single	Rate	Burst m, n (frames)
B1 (STM-16, OC-48)	yes	1E-10 to 2E-5	m = 1 to 196000
B2 (STM-16, OC-48)	yes	1E-10 to 2E-3	m = 1 to 196000
MS-REI (STM-16) REI-L (OC-48)	yes	1E-10 to 2E-3	m = 1 to 196000

Table S-10 Available anomalies in addition to the mainframe instrument

The insertion of **errors** (anomalies) **or alarms** (defects) are mutually exclusive. The action selected first is active.

5.2 Receiver section

5.2.1 Section overhead (SOH), Transport overhead (TOH) evaluation

Display

- SOH, TOH: hexadecimal
- Trace Identifier J0 (STM-16, OC-48): ASCII, plain text

Evaluation

Bit error measurement

- with PRBS11 pseudo-random sequence: E1, F1, E2
D1 to D3, D4 to D12 (byte group)

Output

The overhead channels are output

- in bytes via DCC/ECC interface, socket [21] (V.11): E1, F1, E2 (single byte)
- in byte groups via DCC/ECC interface, socket [21] (V.11): D1 to D3, D4 to D12, K1 to K2 (byte group)



Notes:



Specifications STM-64/OC-192

The STM-64/OC-192 optical interface contains the following options:

- OC-12c/STM-4c Bit Error Testing BN 3035/90.90
- OC-48c/STM-16c Bit Error Testing BN 3035/90.93

The numbers in square brackets [...] correspond to the numbers printed on the instrument.

Calibrated specifications are indicated by ***.

1 Generator section

1.1 Digital signal output

1.1.1 Signal output [103], optical

Connector	2.5 mm (PC)
“Fiber-to-fiber” adapter for direct connection to various 2.5 mm connector types	see list of accessories
Output level ***	0 dBm \pm 1 dBm
Wavelength (switchable, depending on option)	1550 nm (1520 to 1580 nm)
Laser class to EN 60825-1:1994, Normal operation1
Fault condition	3A

LASER ON status display

LED is on when the laser source is active.

1.2 Clock generator and bit rates

1.2.1 Internal clock generation

See "Specifications" for the mainframe instrument.

Permissible clock offset ± 50 ppm

1.2.2 External clock generation [101]

For feeding in a jitter-modulated clock signal that must be derived from the base module clock.

Clock frequency 9953.28 Mbit/s

Connector unbalanced (coaxial)

Socket SMA

Clock input impedance 50 Ω

Input voltage range 100 mVpp to 600 mVpp

1.2.3 Bit rate

STM-64/OC-192 9953.28 Mbit/s

1.2.4 Clock output [102]

For the Generator clock

Frequency 9953.28 MHz

Connector unbalanced (coaxial)

Socket SMA

Output impedance 50 Ω

Output voltage ≥ 50 mVpp

1.2.5 Frame trigger output [100]

No-load output voltage CMOS levels

Socket BNC

Output impedance approx. 50 Ω

1.3 SDH and SONET TX signals

- Generates a STM-64 signal conforming to ITU-T recommendation G.707.
- Generates an OC-192 signal conforming to the Bellcore-GR-1377 standards.

1.3.1 STM-64 TX signal

STM-64 signal formation:

- one AUG1 signal (STM-1 level), generated internally x 64 (64 x AU-4 or 192 x AU-3)
- one AUG4 signal (STM-4c level)¹, generated internally x 16 (16 x AU-4-4c)
- one AUG16 signal (STM-16c level)¹, generated internally x 4 (4 x AU-4-16c)
- one AUG1 signal (STM-1 level), generated internally (AU-4 or AU-3), the other 63 AUG1 signals loaded with HP-UNEQ
- one AUG4 signal (STM-4c level)¹, generated internally, the other 60 AUG1 signals loaded with HP-UNEQ
- one AUG16 signal (STM-16c level)¹, generated internally, the other 48 AUG1 signals loaded with HP-UNEQ

¹ Also see "Concatenated Mappings OC-12c/STM-4c OC-48c/STM-16c" operating manual

1.3.2 OC-192 TX signal

OC-192 signal formation:

- one STS-1 signal, generated internally x 192
- one STS-3c signal, generated internally x 64
- one STS-12c signal¹, generated internally x 16
- one STS-48c signal¹, generated internally x 4
- one STS-1 signal, generated internally, the other 191 STS-1 signals loaded with UNEQ
- one STS-3c signal, generated internally, the other 189 STS-1 signals loaded with UNEQ
- one STS-12c signal¹, generated internally, the other 180 STS-1 signals loaded with UNEQ
- one STS-48c signal¹, generated internally, the other 144 STS-1 signals loaded with UNEQ

¹ See also Operating Manual "Concatenated Mappings OC-12c/STM-4c OC-48c/STM-16c"

1.3.3 Scrambling

Scrambling is as per ITU-T recommendation G.707, ANSI Standard T1.105 and Bellcore GR-253.

The scrambler cannot be switched off.

1.3.4 Overhead generator

STM-64/OC-192 overhead

See Tab. S-1, Page S-51.

- Exceptions:
- The pointer row of the SOH (#1 through #64) or the TOH (#1 through #192) cannot be user defined.
 - Settings are only possible in the ranges #1 through #16 (SOH) or #1 through #48 (TOH) for the "SQ" byte sequence.

Overhead byte loading

- Static bytes: All except B1, B2, H1, H2, H3
- Trace Identifier: J0 (Length = 16 frames with CRC7 formation)
- Dynamic byte groups with pseudo random bit sequence PRBS11 (only possible if channel #1 of the STM-N/OC signal is selected): D1 to D3, D4 to D12 (byte group)
- Dynamic via DCC/ECC interface socket [21] (V.11): E1, F1, E2 (single byte)
- Dynamic via DCC/ECC interface socket [21] (V.11): D1 to D3, D4 to D12, K1 to K2 (byte group)

STM-1, OC-3, OC-1 standard overhead

See "STM-1 mappings / STS-1 mappings" operating manual.

Row 4 of the SOH / POH

Row 4 depends on the mapping set.

Corresponding information is found in Sec. 1.3.4.1, Page S-52 and Sec. 1.3.4.2, Page S-55.

H1 and H2 depend on the pointer address setting (pointer address = 0 is shown). H3 depends on whether a pointer action takes place or not.

1.3.4.1 ITU-T Standard

STM-0 level

Containers = VC3, VC2, VC12, VC11/TU12, VC11/TU11

Overhead #1								
H1	-	-	H2	-	-	H3	-	-
XX	-	-	XX	-	-	XX	-	-

STM-1 level

AU-3, containers = VC3, VC2, VC12, VC11/TU12, VC11/TU11

Overhead #1								
H1	H1	H1	H2	H2	H2	H3	H3	H3
XX	XX	XX	XX	XX	XX	XX	XX	XX

AU-4, containers = VC4, VC3, VC2, VC12, VC11/TU12, VC11/TU11

Overhead #1								
H1	Y	Y	H2	-	-	H3	H3	H3
XX	XX	XX	XX	XX	XX	XX	XX	XX

STM-4 level

AU-3, containers = VC3, VC2, VC12, VC11/TU12, VC11/TU11

Overhead #1, #2, #3, #4								
H1	H1	H1	H2	H2	H2	H3	H3	H3
XX	XX	XX	XX	XX	XX	XX	XX	XX

AU-4, containers = VC4, VC3, VC2, VC12, VC11/TU12, VC11/TU11

Overhead #1, #2, #3, #4								
H1	Y	Y	H2	-	-	H3	H3	H3
XX	XX	XX	XX	XX	XX	XX	XX	XX



AU-4, container = VC4c

Overhead #1								
H1	Y	Y	H2	-	-	H3	H3	H3
XX	XX	XX	XX	XX	XX	XX	XX	XX

Overhead #2, #3, #4								
Y	Y	Y	-	-	-	H3	H3	H3
XX	XX	XX	XX	XX	XX	XX	XX	XX

AU-4, container = VC4v

Overhead #1,#2 #3, #4								
H1	Y	Y	H2	-	-	H3	H3	H3
XX	XX	XX	XX	XX	XX	XX	XX	XX

STM-16 level

AU-3, containers = VC3, VC2, VC12, VC11/TU12, VC11/TU11

Overhead #1 through #16								
H1	H1	H1	H2	H2	H2	H3	H3	H3
XX	XX	XX	XX	XX	XX	XX	XX	XX

AU-4, containers = VC4, VC3, VC2, VC12, VC11/TU12, VC11/TU11

Overhead #1 through #16								
H1	Y	Y	H2	-	-	H3	H3	H3
XX	XX	XX	XX	XX	XX	XX	XX	XX

AU-4, container = VC4c

Overhead #1, #5, #9, #13								
H1	Y	Y	H2	-	-	H3	H3	H3
XX	XX	XX	XX	XX	XX	XX	XX	XX

Overhead #2, #3, #4, #6, #7, #8, #10, #11, #12, #14, #15, #16								
Y	Y	Y	-	-	-	H3	H3	H3
XX	XX	XX	XX	XX	XX	XX	XX	XX

AU-4, container = VC16c

Overhead #1								
H1	Y	Y	H2	-	-	H3	H3	H3
XX	XX	XX	XX	XX	XX	XX	XX	XX

Overhead #2 through #16								
Y	Y	Y	-	-	-	H3	H3	H3
XX	XX	XX	XX	XX	XX	XX	XX	XX

STM-64 level

AU-3, containers = VC3, VC2, VC12, VC11/TU12, VC11/TU11

Overhead #1 through #64								
H1	H1	H1	H2	H2	H2	H3	H3	H3
XX	XX	XX	XX	XX	XX	XX	XX	XX

AU-4, containers = VC4, VC3, VC2, VC12, VC11/TU12, VC11/TU11

Overhead #1 through #64								
H1	Y	Y	H2	-	-	H3	H3	H3
XX	XX	XX	XX	XX	XX	XX	XX	XX

AU-4, container = VC4c

Overhead #1, #5, #9, #13, #17, #21, #25, #29, #33, #37, #41, #45, #49, #53, #57, #61								
H1	Y	Y	H2	-	-	H3	H3	H3
XX	XX	XX	XX	XX	XX	XX	XX	XX

Overhead #2, #3, #4, #6, #7, #8, #10, #11, #12, #14, #15, #16, #18, #19, #20, #22, #23, #24, #26, #27, #28, #30, #31, #32, #34, #35, #36, #38, #39, #40, #42, #43, #44, #46, #47, #48, #50, #51, #52, #54, #55, #56, #58, #59, #60, #62, #63, #64								
Y	Y	Y	-	-	-	H3	H3	H3
XX	XX	XX	XX	XX	XX	XX	XX	XX

AU-4, container = VC16c

Overhead #1, #17, #33, #49								
H1	Y	Y	H2	-	-	H3	H3	H3
XX	XX	XX	XX	XX	XX	XX	XX	XX

Overhead #2 through #16, #18 through #32, #34 through #48, #50 through #64								
Y	Y	Y	-	-	-	H3	H3	H3
XX	XX	XX	XX	XX	XX	XX	XX	XX

1.3.4.2 ANSI Standard

STS-1 (OC-1)

Containers = STS1SPE, VT6SPE, VT2SPE, VT1.5SPE

Overhead #1								
H1	-	-	H2	-	-	H3	-	-
XX	-	-	XX	-	-	XX	-	-

STS-3 (OC-3)

Containers = STS1SPE, VT6SPE, VT2SPE, VT1.5SPE

Overhead #1, #2, #3								
H1	-	-	H2	-	-	H3	-	-
XX	-	-	XX	-	-	XX	-	-

Container = STS3cSPE

Overhead #1								
H1	H1	H1	H2	H2	H2	H3	H3	H3
XX	XX	XX	XX	XX	XX	XX	XX	XX

STS-12 (OC-12)

Containers = STS1SPE, VT6SPE, VT2SPE, VT1.5SPE

Overhead #1 through #12								
H1	-	-	H2	-	-	H3	-	-
XX	-	-	XX	-	-	XX	-	-

Containers = STS3cSPE, STS12cSPE, STS12vSPE

Overhead #1 through #4								
H1	H1	H1	H2	H2	H2	H3	H3	H3
XX	XX	XX	XX	XX	XX	XX	XX	XX

STS-48 (OC-48)

Containers = STS1SPE, VT6SPE, VT2SPE, VT1.5SPE

Overhead #1 through #48								
H1	-	-	H2	-	-	H3	-	-
XX	-	-	XX	-	-	XX	-	-

Containers = STS3cSPE, STS12cSPE, STS48cSPE

Overhead #1 through #16								
H1	H1	H1	H2	H2	H2	H3	H3	H3
XX	XX	XX	XX	XX	XX	XX	XX	XX

STS-192 (OC-192)

Containers = STS1SPE, VT6SPE, VT2SPE, VT1.5SPE

Overhead #1 through #192								
H1	-	-	H2	-	-	H3	-	-
XX	-	-	XX	-	-	XX	-	-

Containers = STS3cSPE, STS12cSPE, STS48cSPE

Overhead #1 through #64								
H1	H1	H1	H2	H2	H2	H3	H3	H3
XX	XX	XX	XX	XX	XX	XX	XX	XX

1.3.5 Error insertion (anomalies)

The following anomalies can be inserted in addition to those in the mainframe instrument:

Anomaly	Single	Rate	Burst m, n (frames)
B1 (STM-64/OC-192)	yes	1E-10 to 2E-5	m = 1 to 196000
B2 (STM-64/OC-192)	yes	1E-10 to 1E-3	m = 1 to 196000
MS-REI (STM-64) REI-L (OC-192)	yes	1E-10 to 1E-3	m = 1 to 196000

Table S-2 Anomalies available in addition to the mainframe instrument

The insertion of **errors** (anomalies) **or alarms** (defects) are mutually exclusive. The action selected first is active.

1.3.6 Alarm generator (defects)

The following defects can be generated in addition to those in the mainframe instrument:

Defect	Test sensor function	Test sensor thresholds	
		M in N	----t1---- -----t2-----
-	On/Off	M in N	----t1---- -----t2-----
LOS (optical)	yes	M = 800 to 7200 N = 1600 to 8000	t1 = 0.1 to 60.0 s t2 = 0.2 to 600 s
LOF-9953	yes	M = 1 to N - 1 N = 1 to 8000	t1 = 0.1 to 60.0 s t2 = 0.2 to 600 s
RS-TIM (STM-64) TIM-L (OC-192)	yes	-	-
MS-AIS (STM-64) AIS-L (OC-192)	yes	M = 1 to N - 1 N = 1 to 8000	t1 = 0.1 to 60.0 s t2 = 0.2 to 600 s
MS-RDI (STM-64) RDI-L (OC-192)	yes	M = 1 to N - 1 N = 1 to 8000	t1 = 0.1 to 60.0 s t2 = 0.2 to 600 s

Table S-3 Defects available in addition to the mainframe instrument

The insertion of **alarms** (defects) **or errors** (anomalies) are mutually exclusive. The action selected first is active.

2 Receiver section

2.1 Digital signal input

2.1.1 Signal input [113], optical



Caution

Destruction of input [113]

The maximum input level of 0 dBm must not be exceeded. Otherwise, the optical input may be destroyed.

⇒ Insert an optical attenuator if a higher input level is expected.

Connector	2.5 mm (PC)
“Fiber-to-fiber” adapter for direct connection to various 2.5 mm connector types	see list of accessories
Input sensitivity	
STM-64 / OC-192 ***	-4 to -15 dBm
Max. permitted input level	0 dBm
Wavelength	1500 to 1600 nm

Optical signal level display

Resolution	1 dBm
Accuracy	±3 dB

LOS (Loss of Signal) status display

LED is on when the signal input is active but no signal is present.

LOS threshold	< -15 dBm
---------------------	-----------



2.2 Outputs for RX clock and frame trigger

2.2.1 Clock output [112]

For the recovered receive clock

Frequency	9958.28 MHz
Connector	unbalanced (coaxial)
Socket	SMA
Output impedance	50 Ω
Output voltage	≥ 70 mVpp

2.2.2 Frame trigger output [110]

No-load output voltage	CMOS level
Socket	BNC
Impedance	approx. 50 Ω

2.3 SDH and SONET RX signals

- Evaluation of STM-64 signal conforming to ITU-T recommendation G.707
- Evaluation of OC-192 signal conforming to Bellcore GR-1377 standards

2.3.1 STM-64 RX signal

STM-64 signal evaluation:

- Analysis of SOH and demultiplexing of one channel, further analysis in mainframe

2.3.2 OC-192 RX signal

OC-192 signal evaluation:

- Analysis of TOH and demultiplexing of one STS-1 or STS-3c channel, further analysis in mainframe

2.3.3 Descrambling

Descrambling is as per ITU-T recommendation G.707, ANSI Standard T1.105 and Bellcore GR-253.

The descrambler cannot be switched off.

2.4 Measurement modes

2.4.1 Alarm detection (defects)

The following alarms can be evaluated and displayed in addition to the alarm detection functions given in the mainframe instrument:

Defect	LED
LOS (optical)	LOS
LOF-9953	LOF/OOF
RS-TIM (STM-64) TIM-L (OC-192)	-
MS-AIS (STM-64) AIS-L (OC-192)	MS-AIS/AIS-L
MS-RDI (STM-64) RDI-L (OC-192)	MS-RDI/RDI-L

Table S-4 LED displays for additional defects

2.4.2 Error measurements (anomalies)

The following anomalies can be evaluated and displayed in addition to the error measurements given in the mainframe instrument:

Anomaly	LED
OOF-9953	LOF/OOF
B1 (STM-64/OC-192)	B1/B2
B2 (STM-64/OC-192)	B1/B2
MS-REI (STM-64) REI-L (OC-192)	-

Table S-5 LED displays for additional anomalies

Evaluation and display of B2 errors (STM-64/OC-192) refers to all test channels taken together.



2.4.3 Section overhead (SOH) #1 to #64, Transport overhead (TOH) #1 to #192 evaluation

Display

- SOH #1, TOH #1 hexadecimal
Except: B1, B2, H1 to H3
- Trace Identifier J0 (STM-64/OC-192) ASCII, plain text

Evaluation

Bit error measurement

- with PRBS11 pseudo-random sequence: E1, F1, E2 (single byte)
D1 to D3, D4 to D12 (byte group)

Output

The overhead channels are output

- in bytes via DCC/ECC interface, socket [21] (V.11): E1, F1, E2 (single byte)
- in byte groups via DCC/ECC interface, socket [21] (V.11): D1 to D3, D4 to D12, K1 to K2 (byte group)

3 Optical power splitter BN 3035/90.49

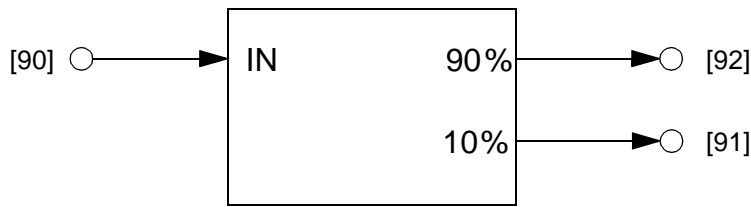

Fig. S-1 Optical power splitter

3.1 Wavelength ranges

“1310 nm”	1260 to 1360 nm
“1550 nm”	1500 to 1600 nm

3.2 Attenuation

Between “IN” [90] and “90%” [92]	1.0 dB (typically), < 1.6 dB
Between “IN” [90] and “10%” [91]	10.5 dB (typically), 8.8 to 12.0 dB



4 Note for ANT-20SE users

The following hardware and software bundles have been formed for the ANT-20SE.

Assignments of modules and software ANT-20SE – ANT-20/ANT-20E:

	Module / Software	BN number ANT-20SE	Equivalent BN number
ANT-20SE Mainframe	Mainframe, SDH	3060/01	3035/41 or 3035/21 + 3035/92.15 + 3035/93.11 + 3035/90.01
	Mainframe, SONET	3060/02	3035/42 or 3035/22 + 3035/92.15 + 3035/93.11 + 3035/90.10
	Extended SDH Testing	3060/90.01	3035/90.02, 3035/90.03, 3035/90.04, 3035/90.05, 3035/90.06, 3035/90.15
	Extended SONET Testing	3060/90.02	3035/90.11, 3035/90.12, 3035/90.13, 3035/90.03, 3035/90.15
	Add SONET (SONET expansion for SDH mainframe)	3060/90.03	3035/90.10, 3035/90.11, 3035/90.12, 3035/90.13, 3035/90.34
	Add SDH (SDH expansion for SONET mainframe)	3060/90.04	3035/90.01, 3035/90.02, 3035/90.04, 3035/90.05, 3035/90.06, 3035/90.33
	Drop&Insert (Through mode, Block&Replace)	3060/90.10	3035/90.20
	PDH MUX/DEMUX (64/140)	3060/90.11	3035/90.30
	M13 MUX/DEMUX	3060/90.12	3035/90.32
Optics STM-1/4, OC-1/3/12	STM-1, OC-1/3 1310 nm	3060/91.01	3035/90.43 + 2 Adapters
	STM-1, OC-1/3 1310 nm & 1550 nm	3060/91.02	3035/90.45 + 2 Adapters
	STM-1/4, OC-1/3/12 1310 nm	3060/91.11	3035/90.46 + 2 Adapters
	STM-1/4, OC-1/3/12 1310 nm & 1550 nm	3060/91.12	3035/90.48 + 2 Adapters
	Optical power splitter	3060/91.05	3035/90.49 + 3 Adapters
	OC-12c BULK	3060/90.90	3035/90.90
	OC-12c Virtual concatenation	3060/90.92	3035/90.92

Table O-6 Assignments of modules and software

	Module / Software	BN number ANT-20SE	Equivalent BN number
Optics STM-16, OC-48	STM-16, OC-48 1550 nm	3060/91.50	3035/91.53 + 2 Adapters
	STM-16, OC-48 1310 nm	3060/91.51	3035/91.54 + 2 Adapters
	STM-16, OC-48 1310 nm & 1550 nm	3060/91.52	3035/91.59 + 2 Adapters
	STM-16, OC-48 15... nm, special	3060/91.53	3035/90.38 + 2 Adapters
	OC-48c BULK	3060/90.93	3035/90.93
	Package: STM-0/1/4/16 1310 nm + Concatenation	3060/90.55	3035/90.46, 3035/91.54, 3035/90.90, 3035/90.93, + 4 Adapters
	Package: STM-0/1/4/16 1550 nm + Concatenation	3060/90.56	3035/90.47, 3035/91.53, 3035/90.90, 3035/90.93, + 4 Adapters
	Package: STM-0/1/4/16 1310 nm & 1550 nm + Concatenation	3060/90.57	3035/90.48, 3035/91.59, 3035/90.90, 3035/90.93, + 4 Adapters
	Package: STM-0/1/4 1310 nm STM-16 1550 nm + Concatenation	3060/90.58	3035/90.46, 3035/91.53, 3035/90.90, 3035/90.93, + 4 Adapters
Jitter O.172	Package: O.172 Jitter/Wander up to 155 Mbit/s	3060/91.30	3035/90.81, 3035/90.85, 3035/90.82, 3035/90.86
	Package: O.172 Jitter/Wander up to 622 Mbit/s	3060/91.31	3035/91.31
	Package: O.172 Jitter/Wander up to 2488 Mbit/s	3060/91.32	3035/91.32
	MTIE/TDEV Analysis Part of 3060/91.30 to 91.32	-	3035/95.21
ATM	ATM Basic	3060/90.50	3035/90.70
	ATM Comprehensive	3060/90.51	3035/91.80
	Add ATM SDH	3060/90.52	3035/90.72, 3035/90.74, 3035/90.75, 3035/90.77, 3035/90.33
	Add ATM SONET	3060/90.53	3035/90.71, 3035/90.73, 3035/90.76, 3035/90.34,
	OC-12c ATM Testing	3060/90.91	3035/90.91
Accessories	Remote control, V.24	3035/91.01	
	Remote control, GPIB	3035/92.10	
	Remote Operation Modem	3035/95.30	
	Remote Operation LAN/PCMCIA	3035/95.31	
	PDH/SDH NEXT Expert	3035/95.40	
	Test Sequencer	3035/95.90	
	LabWindows/CVI drivers	3035/95.99	
	Calibration report	3035/94.01	
	Transport case	3035/92.03	

Table O-6 Assignments of modules and software